





## 入賞チーム

### ● ジャスティング : Jousting

小学生 / Elementary School



Rank	Country	No.	Name
1	 TWN	E13	Tainan Wujia Luxembourg Knights
2	 TWN	E14	Tainan Wujia Stars
3	 TWN	E15	Tainan Wujia Glory

中学生 / Middle School



Rank	Country	No.	Name
1	 TWN	M13	Love Tainan
2	 TWN	M09	SDJH-1
3	 TWN	M10	SDJH-2

### ● アメージング : a-MAZE-ing

小学生 / Elementary School



Rank	Country	No.	Name
1	 TWN	E35	Tainan Haidong Gold Brains
2	 TWN	E23	Unexpected
2	 TWN	E36	Wenhua Miracle

中学生 / Middle School



Rank	Country	No.	Name
1	 TWN	M09	SDJH-1
2	 TWN	M23	NKDE
3	 TWN	M10	SDJH-2

### ● ラインフォロイング : Line Following

小学生 / Elementary School

Rank	Country	No.	Name
1	 CHN	E54	Blue Light Delta
2	 CHN	E52	Blue Light Atlas
3	 CHN	E41	Blue Light BB8

中学生 / Middle School



Rank	Country	No.	Name
1	 TWN	M13	Love Tainan
2	 CHN	M36	CKWA HRC Wolf
3	 CHN	M41	JIZHI-Galaxy

高校生 / High School



Rank	Country	No.	Name
1	 TWN	H12	Tainan Ying-Hai Haidong No.1
2	 JPN	H05	DJ-Side Winder
3	 JPN	H07	DJ-Nouveau

●スモーボット : Sumobot



小学生 / Elementary School

Rank	Country	No.	Name
1	 CHN	E56	Legend Education-C
2	 JPN	E68	HIRYU
3	 CHN	E50	BOCA-Hero



中学生 / Middle School

Rank	Country	No.	Name
1	 CHN	M34	CoCode.Curiosity
2	 CHN	M42	Legend Education-A
3	 TWN	M28	Tainan Annan Haidong No.1

高校生 / High School

Rank	Country	No.	Name
1	 JPN	H06	DJ-Drei Berge
2	 JPN	H05	DJ-Side Winder
3	 TWN	H13	Profession Stone

●ファイヤーファイティング : Fire Fighting

Rank	Country	No.	Name
1	 JPN	H09	DJ-Fire truck
2	 JPN	M32	TYHY
3	 TWN	H12	Tainan Ying-Hai Haidong No.1

●ロボットバイト : Robotovate

Rank	Country	No.	Name
1	 JPN	H02	ウオクシオン
2	 TWN	H12	Tainan Ying-Hai Haidong No.1
3	 JPN	H04	DJ-Omni

ランキング結果

a-MAZE-ing 小学生の部 / Elementary School

Seq	Rank	Country	No.	Name	Point
1	1	 TWN	E23	Unexpected	3075
2	2	 TWN	E36	Wenhua Miracle	3073
3	3	 TWN	E35	Tainan Haidong Gold Brains	3065
4	4	 JPN	E58	インフィニットマインド	3053
5	5	 JPN	E83	レインボーサンダース	3050
6	6	 JPN	E80	台風100号	3043
7	7	 JPN	E29	三木小第一	3040
8	8	 JPN	E88	ロボくん	3039
9	9	 JPN	E82	チーム湖北Ⅱ	3034
10	10	 JPN	E89	SKTJ	3024
11	10	 JPN	E85	OSHIMA兄妹ず	3018
12	12	 JPN	E65	True Place	2900
13	13	 JPN	E30	三木小第二	2882
14	14	 TWN	E34	Tainan Haidong Star	2738
15	15	 JPN	E11	環境保護チーム	2720
16	16	 JPN	E92	ロボット少年隊	2711
17	17	 JPN	E70	9111 (ナインワンイレブン)	2571
18	18	 JPN	E79	DANDYS	2567
19	19	 CHN	E46	CKWA HRC Pilot	2558
20	20	 JPN	E84	ケチャッピー	2552
21	21	 JPN	E10	s u nワンダース	2404
22	22	 JPN	E31	亀がわらチーム	2310
23	23	 JPN	E27	めざせ3位以内	2250
24	23	 JPN	E73	T&K	2250
25	23	 JPN	E75	カニさん	2250
26	23	 JPN	E78	パプリカの種	2250
27	27	 JPN	E87	あまがエる	2159
28	28	 JPN	E66	まる	2150
29	28	 JPN	E91	4年チーム	2150
30	30	 JPN	E33	錦城ゴッドチーム	2105
31	31	 JPN	E81	チーム湖北	2050
32	32	 JPN	E07	KR	2000
33	32	 JPN	E72	スカイ	2000
34	34	 JPN	E45	チームスヌーピー	1956
35	35	 TWN	E14	Tainan Wujia Stars	1950
36	35	 JPN	E26	つかめ優勝	1950
37	37	 JPN	E02	チームかえ☆かず	1850
38	37	 JPN	E40	きんひがチッコリ	1850
39	37	 JPN	E69	3ロボーズ (すりーろぼーんず)	1850
40	40	 JPN	E43	チームY!	1800
41	40	 JPN	E44	チームペンギンズ	1800
42	42	 TWN	E15	Tainan Wujia Glory	1750
43	42	 JPN	E21	カービィ	1750
44	44	 JPN	E01	皇帝ペンギン2号	1700
45	44	JPN	E22	ロボドラゴンズ	1700

46	46		JPN	E90	初心者チーム	1650
47	47		JPN	E16	YAMASHIRO FIVE	1600
48	47		JPN	E39	マニュアル	1600
49	49		JPN	E08	プラチナム学習会	1550
50	49		JPN	E17	ロボ2号	1550
51	49		JPN	E37	南ピューター	1550
52	49		JPN	E38	THE・南郷	1550
53	49		JPN	E41	きんひがW	1550
54	54		JPN	E03	つばめ商店	1500
55	54		TWN	E13	Tainan Wujia Luxembourg Knights	1500
56	54		JPN	E71	HIGASHITANIGUCHI	1500
57	57		JPN	E20	アップル君	1400
58	57		JPN	E32	中坂チーム	1400
59	59		JPN	E67	MAX	1350
60	60		JPN	E04	チーム林	1250
61	61		JPN	E74	スマイル	1200
62	62		CHN	E47	CKWA HRC Crane	1100
63	63		JPN	E42	きんひがK	950
64	64		CHN	E55	Legend Education-B	700
65	65		JPN	E06	roundface ののなほ	250
66	66		JPN	E28	矢守社長	0
67	66		CHN	E56	Legend Education-C	0
68	66		JPN	E86	作見6年チーム	0

a-MAZE-ing (小学生/Elementary School)

1回戦

準決勝

3位決定戦

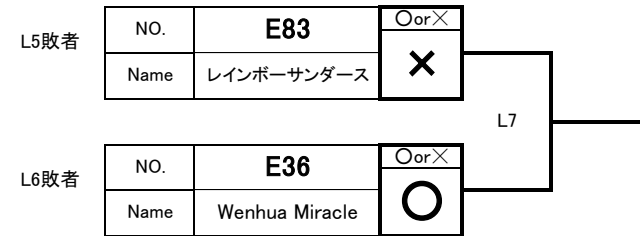
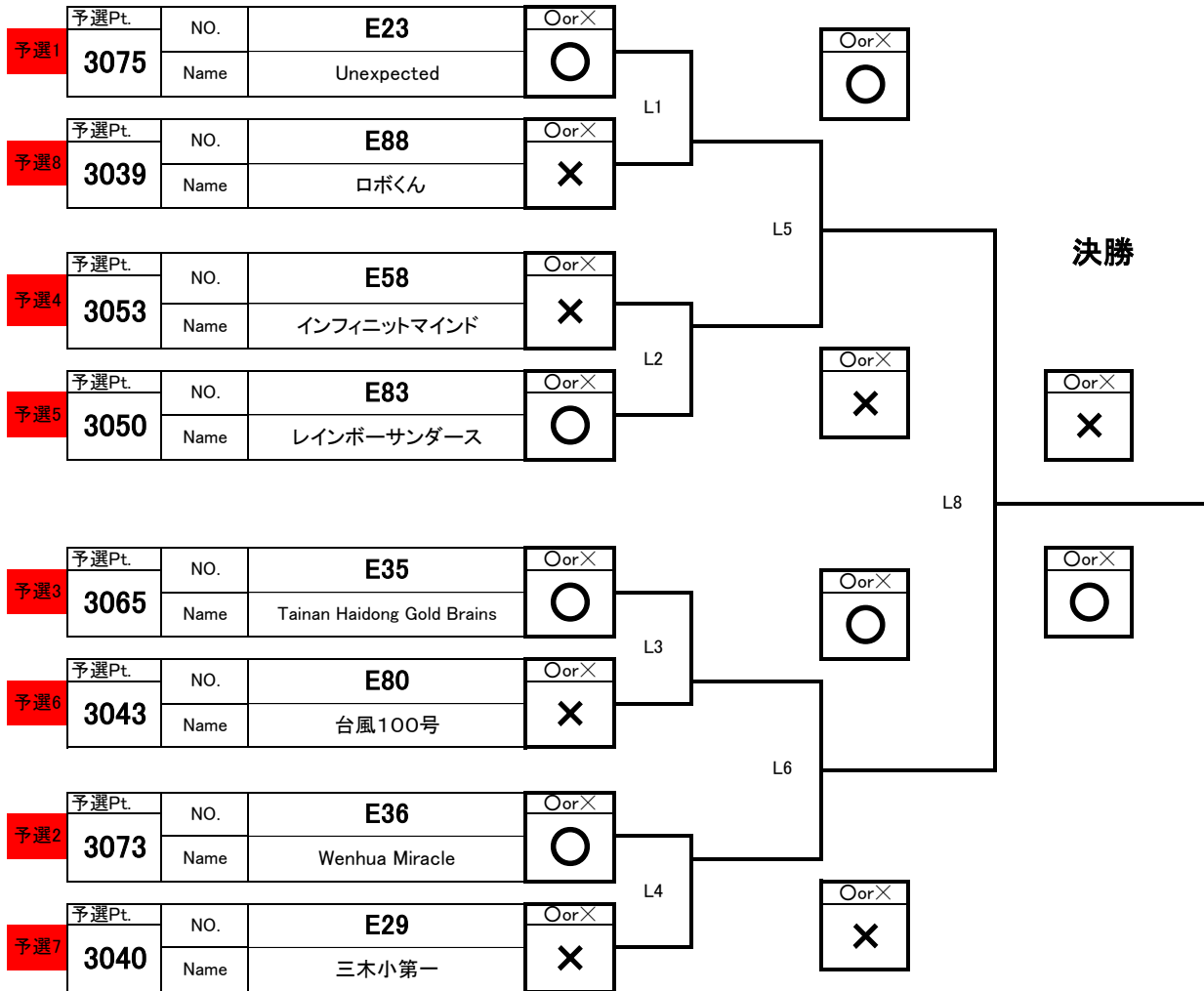

最終結果

1		E35 Tainan Haidong Gold Brains
2		E23 Unexpected
3		E36 Wenhua Miracle
4		E83 レインボーサンダース
5		E58 インフィニットマインド
6		E80 台風100号
7		E29 三木小第一
8		E88 ロボくん

ランキング結果

a-MAZE-ing 中学生の部/Middle School

Seq	Rank	Country	No.	Name	Point
1	1	 TWN	M09	SDJH-1	4560
2	2	 TWN	M23	NKDE	4556
3	3	 TWN	M10	SDJH-2	4551
4	4	 TWN	M28	Tainan Annan Haidong No.1	4545
5	5	 TWN	M27	BROTHERS	4533
6	6	 JPN	M33	yoshihiroka!	4235
7	7	 JPN	M30	東和B	3973
8	8	 JPN	M15	橋立中学校B	3050
9	9	 JPN	M29	Mr.Lemon	2800
10	10	 SIN	M05	Hexacarbonate	2750
11	10	 JPN	M16	橋立中学校C	2750
12	12	 JPN	M01	山代中 A	2600
13	13	 JPN	M11	萌え民	2550
14	13	 JPN	M17	橋立中学校D	2550
15	13	 JPN	M21	橋立中学校H	2550
16	16	 JPN	M19	橋立中学校F	2450
17	17	 JPN	M07	ワオラボSK	2300
18	17	 JPN	M20	橋立中学校G	2300
19	17	 JPN	M47	錦中Bチーム	2300
20	20	 SIN	M06	Hexabot	2250
21	20	 JPN	M22	橋立中学校I	2250
22	22	 SIN	M04	Hexahedron	2000
23	23	 JPN	M14	橋立中学校A	1950
24	23	 JPN	M18	橋立中学校E	1950
25	25	 JPN	M46	錦中Aチーム	1850
26	26	 JPN	M02	山代中 B	750
27	27	 JPN	M03	全教研 A	0
28	27	 CHN	M36	CKWA HRC Wolf	0
29	27	 CHN	M42	Legend Education-A	0

a-MAZE-ing (中学生/Middle School)

1回戦

準決勝

3位決定戦

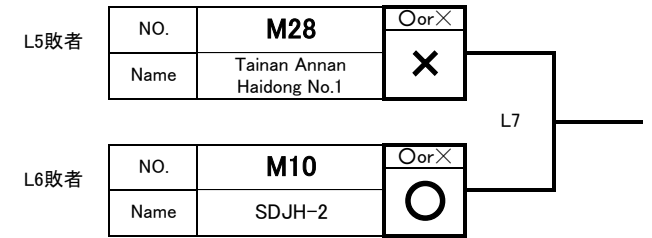
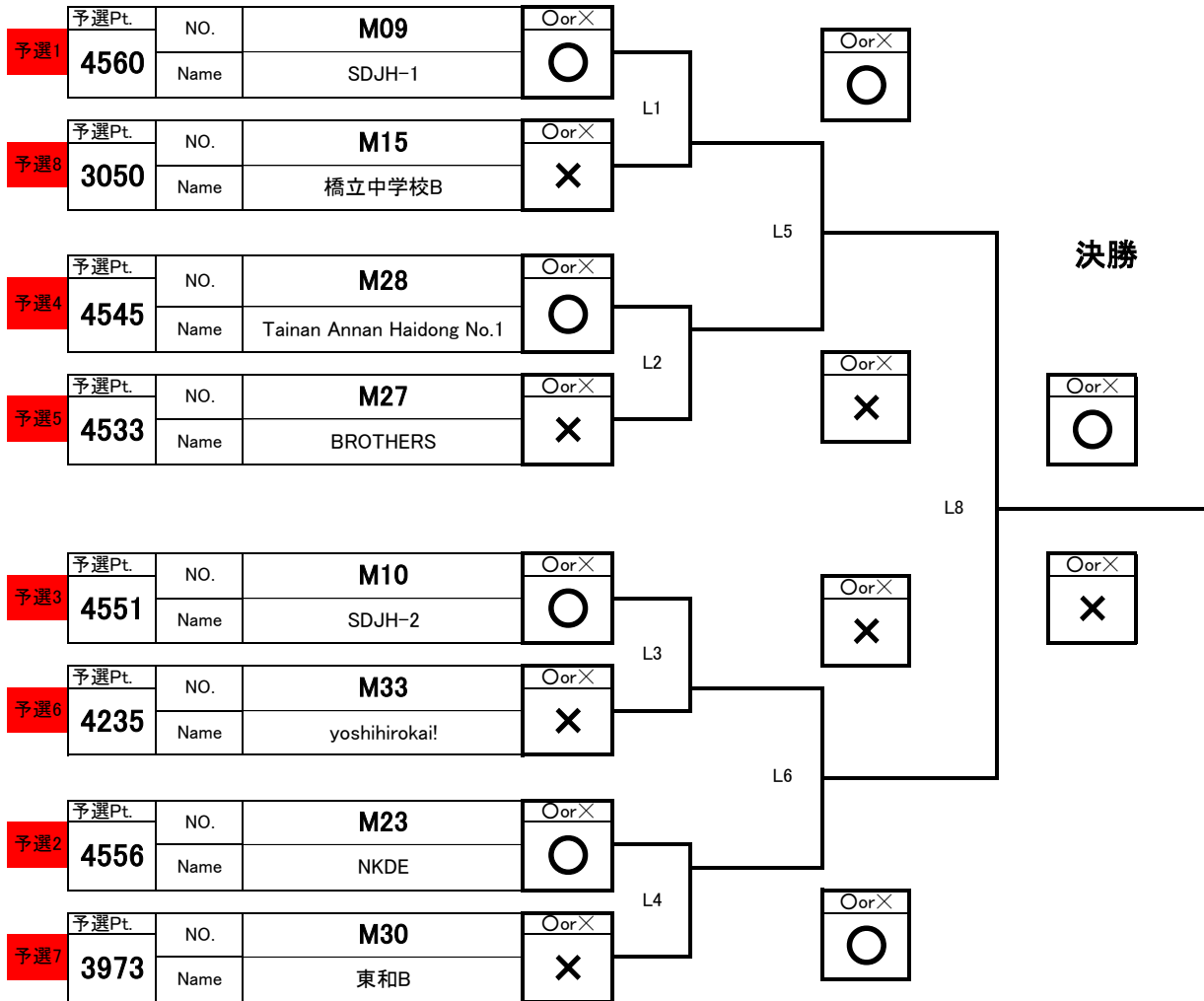

最終結果

1		M09 SDJH-1
2		M23 NKDE
3		M10 SDJH-2
4		M28 Tainan Annan Haidong No.1
5		M27 BROTHERS
6		M33 yoshihirokai!
7		M30 東和B
8		M15 橋立中学校B

ランキング結果

Jousting 小学生の部／Elementary School

Seq	Rank	Country	No.	Name	Point
1	1	 TWN	E15	Tainan Wujia Glory	575
2	2	 TWN	E34	Tainan Haidong Star	560
3	3	 TWN	E13	Tainan Wujia Luxembourg Knights	555
4	4	 TWN	E24	SLPS Super Robot	555
5	5	 TWN	E14	Tainan Wujia Stars	435
6	6	 TWN	E36	Wenhua Miracle	350
7	7	 JPN	E28	矢守社長	325
8	8	 JPN	E63	勅使M	320
9	9	 JPN	E60	勅使K	315
10	10	 JPN	E18	ジーク	310
11	11	 JPN	E64	勅使I	300
12	12	 JPN	E61	勅使T	285
13	12	 JPN	E76	ファイト金明	285
14	14	 JPN	E09	パレスオブザドラゴン	240
15	15	 JPN	E19	さかのえん	205
16	16	 JPN	E35	Tainan Haidong Gold Brains	200
17	17	 JPN	E12	チームHY	100
18	18	 JPN	E77	金明ズ	95
19	19	 JPN	E92	ロボット少年隊	50
20	20	 JPN	E86	作見6年チーム	0
21	20	 JPN	E87	あまがえる	0
22	20	 JPN	E88	ロボくん	0
23	20	 JPN	E89	SKTJ	0
24	20	 JPN	E90	初心者チーム	0
25	20	 JPN	E91	4年チーム	0

# Jousting (小学生/Elementary School)

## 1回戦

## 準決勝

## 3位決定戦

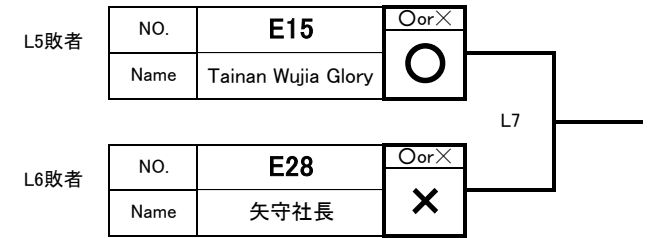
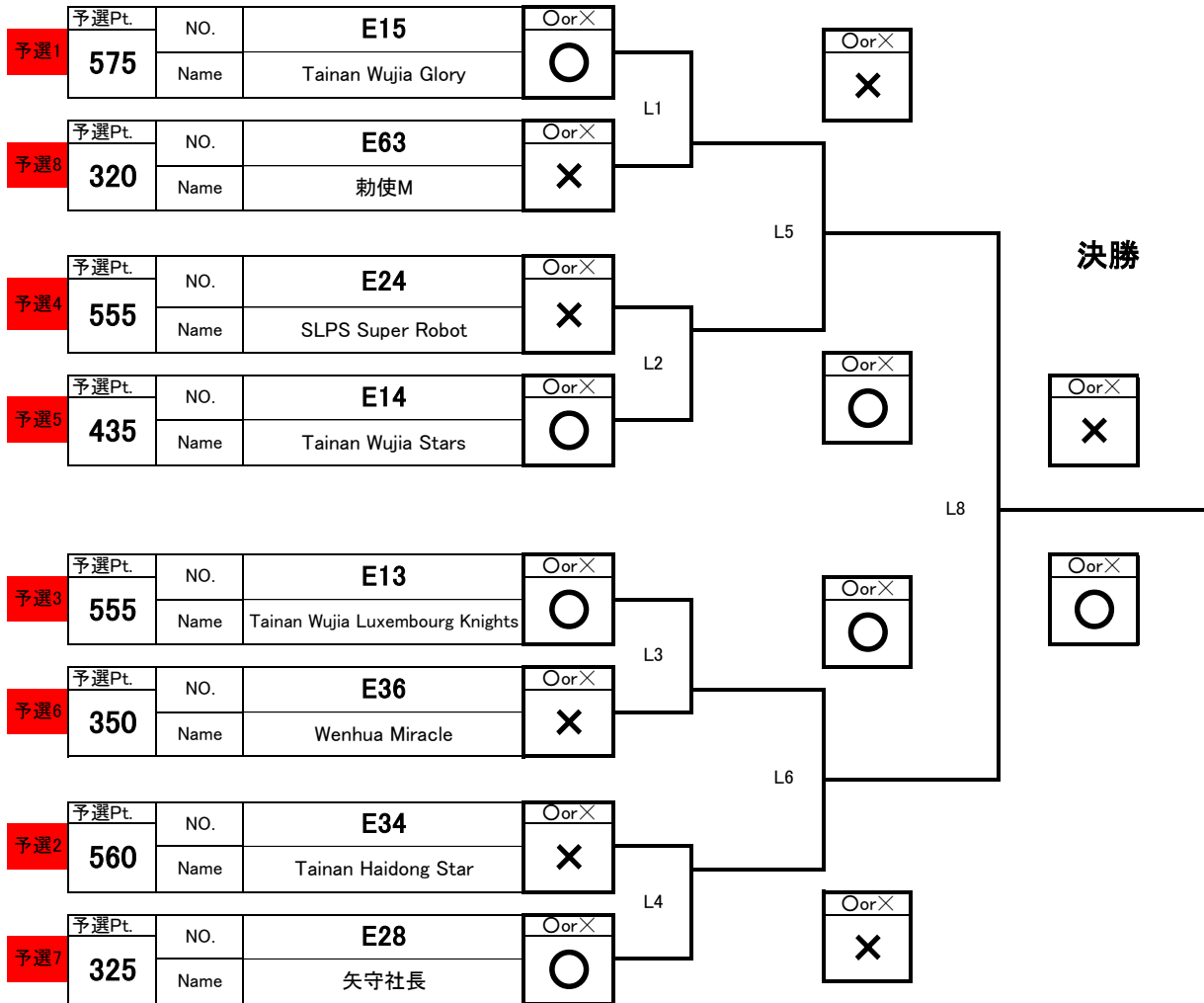









## 最終結果

1		<b>E13</b> Tainan Wujia Luxembourg Knights
2		<b>E14</b> Tainan Wujia Stars
3		<b>E15</b> Tainan Wujia Glory
4		<b>E28</b> 矢守社長
5		<b>E34</b> Tainan Haidong Star
6		<b>E24</b> SLPS Super Robot
7		<b>E36</b> Wenhua Miracle
8		<b>E63</b> 勅使M

ランキング結果

Jousting 中学生の部/Middle School

Seq	Rank	Country	No.	Name	Point
1	1	 JPN	EM26	山中こいこい踊り	675
2	2	 TWN	EM10	SDJH-2	635
3	3	 TWN	EM09	SDJH-1	585
4	4	 TWN	EM13	Tainan Wujia Luxembourg Knights	555
5	5	 TWN	EM12	Universe taro	495
6	6	 JPN	EM25	team山中glasses	305
7	7	 JPN	EM46	錦中Aチーム	70
8	8	 JPN	EM33	yoshihiro kai!	30
9	9	 JPN	EM47	錦中Bチーム	5

# Jousting (中学生/Middle School)

## 1回戦

## 準決勝

## 3位決定戦

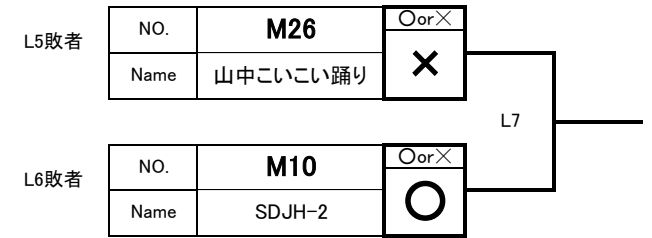
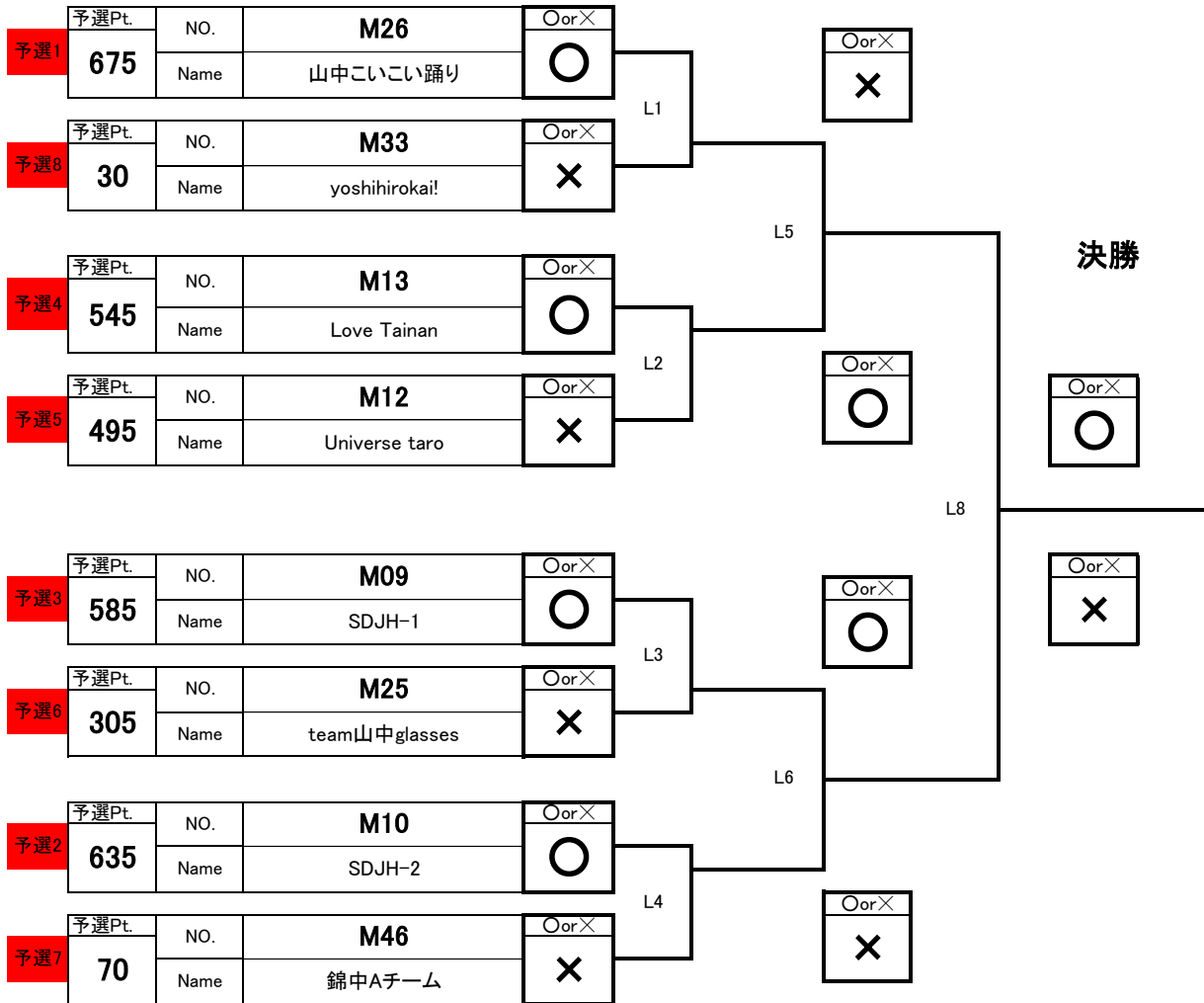

## 最終結果

1		M13 Love Tainan
2		M09 SDJH-1
3		M10 SDJH-2
4		M26 山中こいこい踊り
5		M12 Universe taro
6		M25 team山中glasses
7		M46 錦中Aチーム
8		M33 yoshihiroka!

ランキング結果

Line Following 小学生の部／Elementary School

Seq	Rank	Country	No.	Name	Point
1	1	 CHN	E54	Blue Light Delta	2650
2	2	 CHN	E52	Blue Light Atlas	2650
3	3	 CHN	E53	Blue Light BB8	2650
4	4	 CHN	E49	KnightA	2650
5	5	 CHN	E48	DHWTeam	2650
6	6	 CHN	E34	Tainan Haidong Star	2650
7	7	 TWN	E46	CKWA HRC Pilot	2650
8	8	 JPN	E57	電電龍	2650
9	9	 JPN	E68	HIRYU	2650
10	10	 JPN	E05	H2K	2649
11	10	 JPN	E62	勅使N	2649
12	12	 JPN	E06	roundface なのなほ	2572
13	13	 JPN	E65	True Place	2234
14	14	 JPN	E59	勅使S	2206
15	15	 JPN	E67	MAX	2000
16	16	 CHN	E47	CKWA HRC Crane	750
17	17	 JPN	E25	チーム松原	0
18	17	 JPN	E28	矢守社長	0
19	17	 JPN	E66	まる	0

# Line Following (小学生/Elementary School)

## 1回戦

## 準決勝

## 3位決定戦

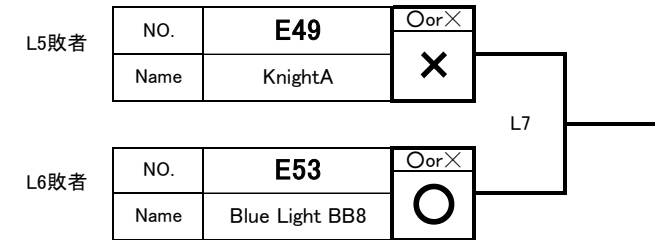
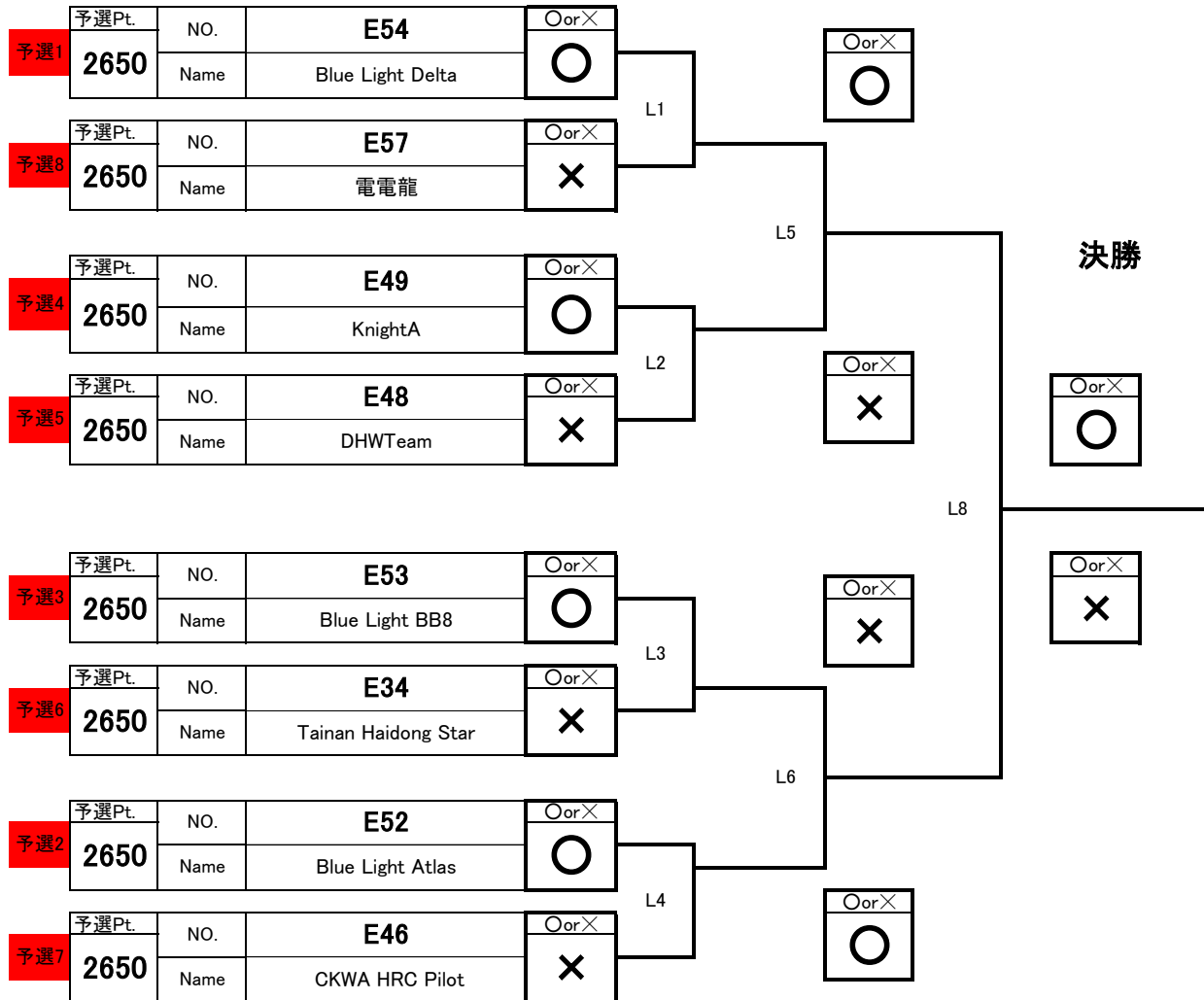

## 最終結果

1		<b>E54</b> Blue Light Delta
2		<b>E52</b> Blue Light Atlas
3		<b>E53</b> Blue Light BB8
4		<b>E49</b> KnightA
5		<b>E48</b> DHWTeam
6		<b>E34</b> Tainan Haidong Star
7		<b>E46</b> CKWA HRC Pilot
8		<b>E57</b> 電電龍

ランキング結果

Line Following 中学生の部/Middle School

Seq	Rank	Country	No.	Name	Point
1	1	 TWN	M28	Tainan Annan Haidong No.1	3150
2	2	 CHN	M41	JIZHI-Galaxy	3150
3	3	 TWN	M13	Love Tainan	3149
4	4	 CHN	M38	Ideas	3149
5	5	 CHN	M36	CKWA HRC Wolf	3132
6	6	 CHN	M40	中国梦	3087
7	7	 JPN	M45	Otemon Sprout	3039
8	8	 TWN	M23	NKDE	2820
9	9	 JPN	M31	TW	2489
10	10	 JPN	M08	ワオラボRH	2188
11	11	 CHN	M39	RRRC	1928
12	12	 SIN	M04	Hexahedron	1700
13	13	 JPN	M43	Shigagakuen's falcom	1650
14	14	 JPN	M24	nada-robot	1475
15	15	 JPN	M44	The glory of shiga gakuen	1250
16	16	 SIN	M06	Hexabot	1050
17	17	 SIN	M05	Hexacarbonate	375
18	18	 CHN	M37	Challenger	0

# Line Following (中学生/Middle School)

## 1回戦

## 準決勝

## 3位決定戦

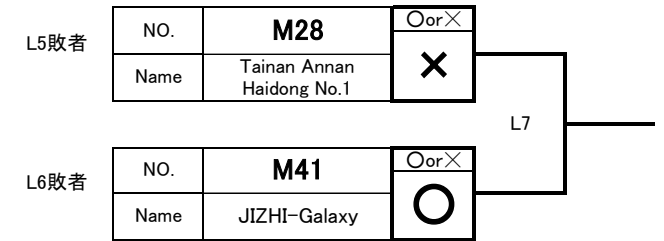
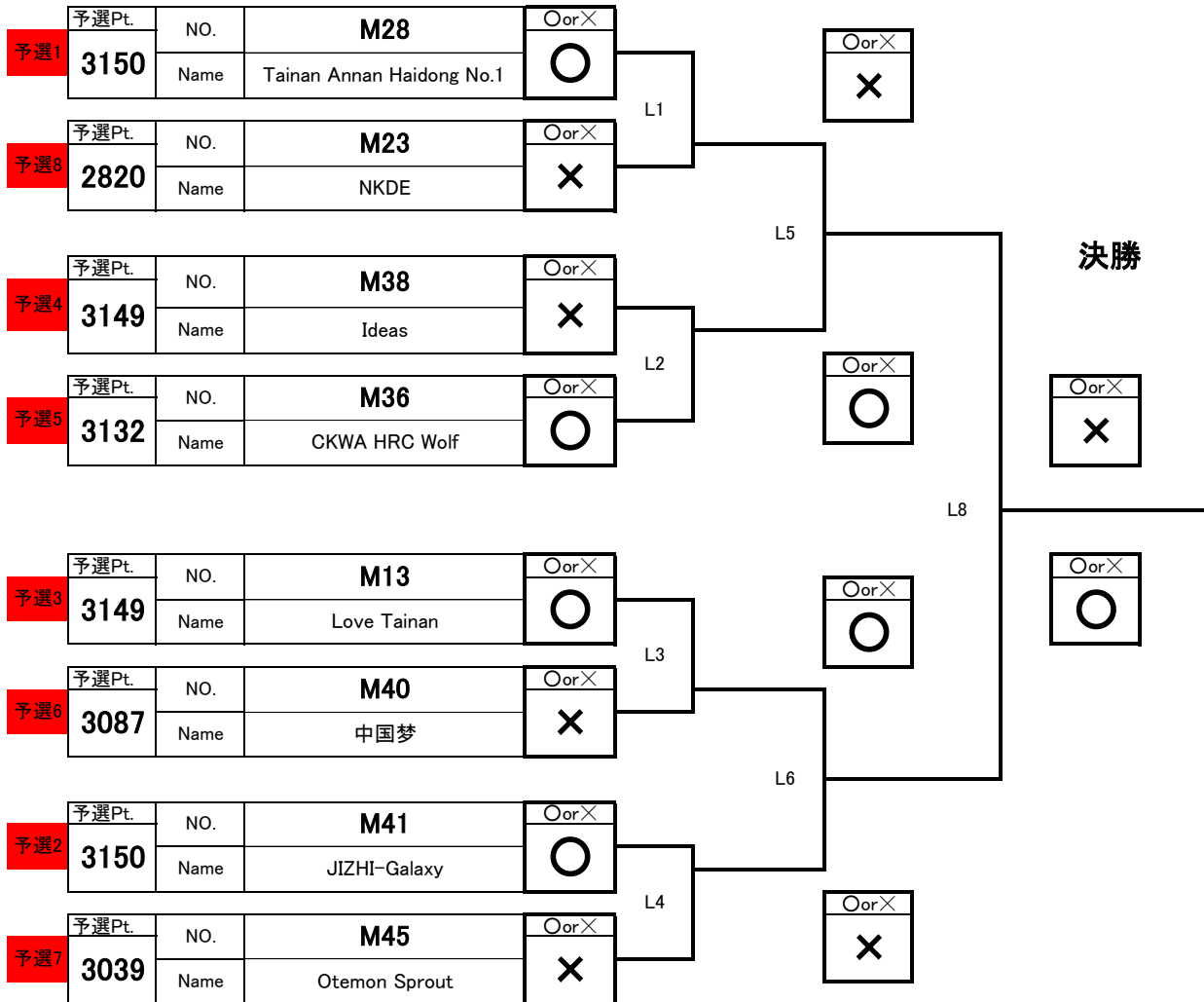

## 最終結果

1		<b>M13</b> Love Tainan
2		<b>M36</b> CKWA HRC Wolf
3		<b>M41</b> JIZHI-Galaxy
4		<b>M28</b> Tainan Annan Haidong No.1
5		<b>M38</b> CKWA HRC Wolf
6		<b>M40</b> 中国梦
7		<b>M45</b> Otemon Sprout
8		<b>M23</b> NKDE

ランキング結果

Line Following 高校生の部 / High School

Seq	Rank	Country	No.	Name	Point
1	1	 TWN	H12	Tainan Ying-Hai Haidong No.1	3650
2	1	 JPN	H04	DJ-Omni	2735
3	3	 JPN	H05	DJ-Side Winder	2645
4	4	 JPN	H07	DJ-Nouveau	2077
5	5	 JPN	H15	ASUKA	1730
6	6	 JPN	H14	滋賀学園中学・高等学校 コンピュータ部	850
7	7	 JPN	H10	MM 5	25
8	8	 JPN	H01	MMGO	0
9	9	 JPN	H11	サイズミ	0

# Line Following (高校生/High School)

## 1回戦

## 準決勝

## 3位決定戦

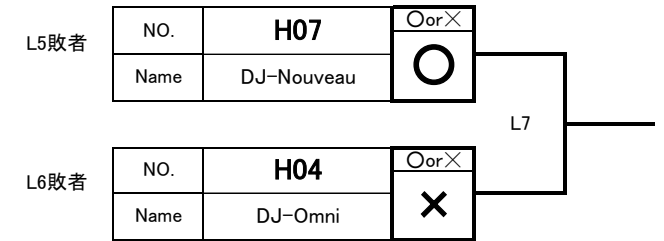
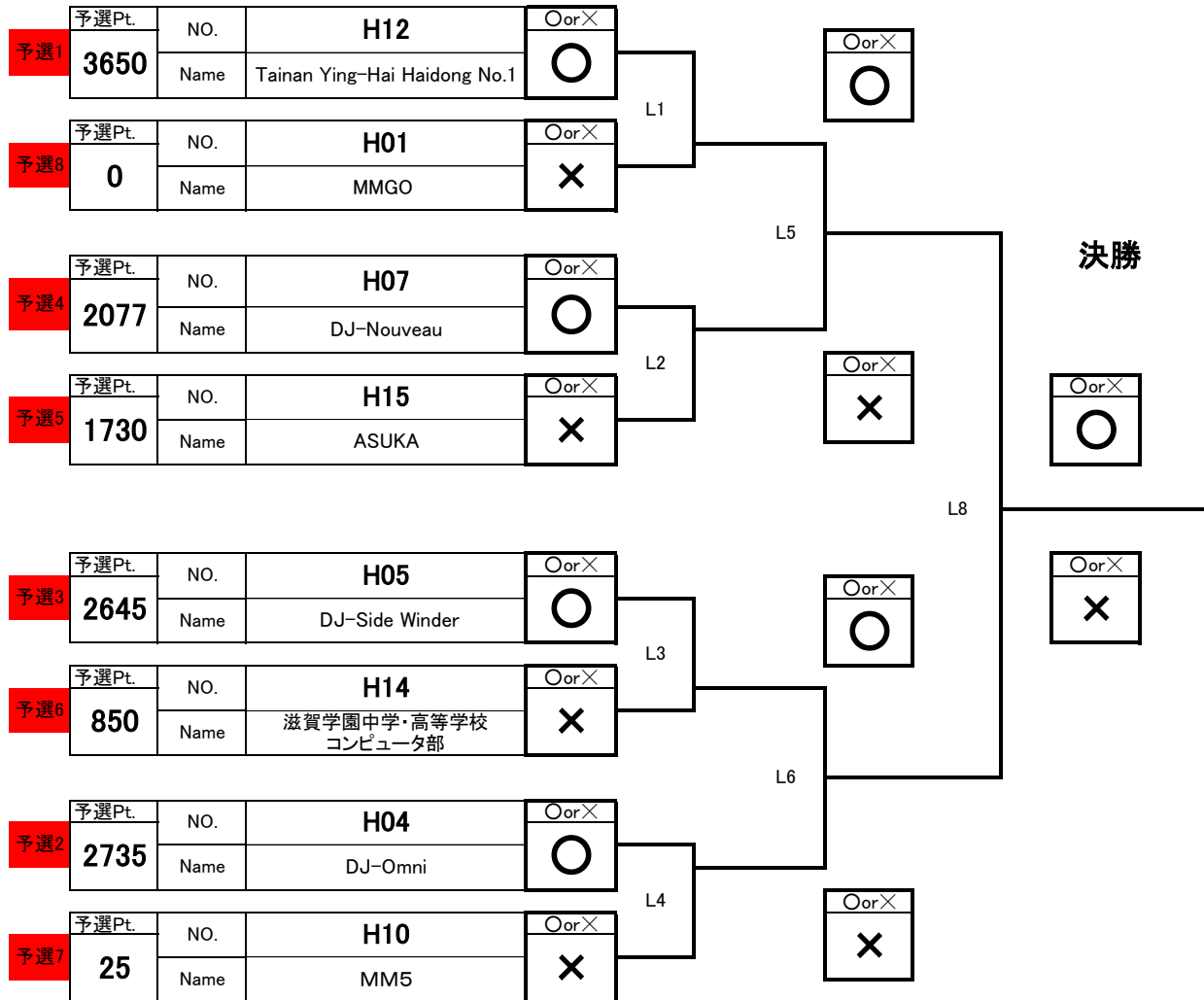

## 最終結果

1		H12 Tainan Ying-Hai Haidong No.1
2		H05 DJ-Side Winder
3		H07 DJ-Nouveau
4		H04 DJ-Omni
5		H15 ASUKA
6		H14 滋賀学園中学・高等学校 コンピュータ部
7		H10 MM5
8		H01 MMGO

ランキング結果

Sumobot 小学生の部 / Elementary School

Seq	Rank	Country	No.	Name	Point
1	1	 TWN	E34	Tainan Haidong Star	59
2	1	 CHN	E55	Legend Education-B	58
3	3	 TWN	E35	Tainan Haidong Gold Brains	55
4	4	 CHN	E56	Legend Education-C	52
5	5	 CHN	E50	BOCA-Hero	51
6	6	 JPN	E66	まる	46
7	7	 JPN	E68	HIRYU	46
8	8	 TWN	E36	Wenhua Miracle	45
9	8	 CHN	E51	BOCA-Legends	40
10	10	 TWN	E23	Unexpected	40
11	11	 JPN	E28	矢守社長	10
12	12	 JPN	E65	True Place	6
13	13	 CHN	E46	CKWA HRC Pilot	0
14	13	 CHN	E47	CKWA HRC Crane	0
15	13	 CHN	E48	DHWTeam	0
16	13	 CHN	E49	KnightA	0
17	13	 JPN	E67	MAX	0

Sumobot (小学生/Elementary School)

1回戦

L1	予選1st	予選Pt.	NO.	E34	Oor	X	}
		59	Name	Tainan Haidong Star		○	
	予選9th	予選Pt.	NO.	E51	Oor	X	
		40	Name	BOCA-Legends		○	
	予選6th	予選Pt.	NO.	E66	Oor	X	}
		46	Name	まる		×	
	予選2nd	予選Pt.	NO.	E55	Oor	X	
		58	Name	Legend Education-B		○	
L2	予選8th	予選Pt.	NO.	E36	Oor	X	}
		45	Name	Wenhua Miracle		×	
	予選5th	予選Pt.	NO.	E50	Oor	X	}
		51	Name	BOCA-Hero		○	
L3	予選3rd	予選Pt.	NO.	E35	Oor	X	}
		55	Name	Tainan Haidong Gold Brains		×	
	予選7th	予選Pt.	NO.	E68	Oor	X	
		46	Name	HIRYU		○	
	予選4th	予選Pt.	NO.	E56	Oor	X	}
		52	Name	Legend Education-C		○	

準決勝

L4	予選1st	NO.	E34	Oor	X	}
		Name	Tainan Haidong Star		×	
	予選7th	NO.	E68	Oor	X	}
		Name	HIRYU		○	
	予選5th	NO.	E50	Oor	X	}
		Name	BOCA-Hero		○	
L5	予選9th	NO.	E51	Oor	X	}
		Name	BOCA-Legends		×	
	予選2nd	NO.	E55	Oor	X	}
		Name	Legend Education-B		○	
	予選4th	NO.	E56	Oor	X	}
		Name	Legend Education-C		○	

決勝















L6	NO.	E50	3rd
	Name	BOCA-Hero	
	NO.	E68	2nd
	Name	HIRYU	
NO.	E56	1st	
Name	Legend Education-C		
NO.	E55	4th	
Name	Legend Education-B		

最終結果

1		E56 Legend Education-C
2		E68 HIRYU
3		E50 BOCA-Hero
4		E55 Legend Education-B
5		E34 Tainan Haidong Star
6		E51 BOCA-Legends
7		E35 Tainan Haidong Gold Brains
8		E66 まる
9		E36 Wenhua Miracle

ランキング結果

Sumobot 中学生の部 / Middle School

Seq	Rank	Country	No.	Name	Point
1	1	 CHN	M34	CoCode.Curiosity	63
2	2	 SIN	M05	Hexacarbonate	59
3	3	 TWN	M28	Tainan Annan Haidong No.1	58
4	4	 CHN	M35	CoCode.Endeavour	55
5	5	 CHN	M42	Legend Education-A	52
6	6	 TWN	M12	Universe taro	48
7	7	 TWN	M13	Love Tainan	45
8	8	 TWN	M27	BROTHERS	37
9	9	 SIN	M04	Hexahedron	33
10	10	 SIN	M06	Hexabot	12
11	11	 JPN	M03	全教研 A	11
12	12	 JPN	M33	yoshihiro kai!	9
13	13	 CHN	M36	CKWA HRC Wolf	0
14	13	 CHN	M37	Challenger	0
15	13	 CHN	M38	Ideas	0

Sumobot (中学生/Middle School)

1回戦

L1	予選1st	予選Pt.	NO.	M34	Oor	×
		63	Name	CoCode.Curiosity		○
	予選9th	予選Pt.	NO.	M04	Oor	×
		33	Name	Hexahedron		○
	予選6th	予選Pt.	NO.	M12	Oor	×
		48	Name	Universe taro		○
L2	予選2nd	予選Pt.	NO.	M05	Oor	×
		59	Name	Hexacarbonate		○
	予選8th	予選Pt.	NO.	M27	Oor	×
		37	Name	BROTHERS		○
	予選5th	予選Pt.	NO.	M42	Oor	×
		52	Name	Legend Education-A		○
L3	予選3rd	予選Pt.	NO.	M28	Oor	×
		58	Name	Tainan Annan Haidong No.1		○
	予選7th	予選Pt.	NO.	M13	Oor	×
		45	Name	Love Tainan		○
	予選4th	予選Pt.	NO.	M35	Oor	×
		55	Name	CoCode.Endeavour		○









準決勝

L4	予選1st	NO.	M34	Oor	×
		Name	CoCode.Curiosity		○
L4	予選7th	NO.	M13	Oor	×
		Name	Love Tainan		○
L4	予選5th	NO.	M42	Oor	×
		Name	Legend Education-A		○
L5	予選6th	NO.	M12	Oor	×
		Name	Universe taro		○
L5	予選8th	NO.	M27	Oor	×
		Name	BROTHERS		○
L5	予選3rd	NO.	M28	Oor	×
		Name	Tainan Annan Haidong No.1		○

決勝

L6	NO.	M34	1st
	Name	CoCode.Curiosity	
L6	NO.	M42	2nd
	Name	Legend Education-A	
L6	NO.	M12	4th
	Name	Universe taro	
L6	NO.	M28	3rd
	Name	Tainan Annan Haidong No.1	

最終結果

1		M34 CoCode.Curiosity
2		M42 Legend Education-A
3		M28 Tainan Annan Haidong No.1
4		M12 Universe taro
5		M13 Love Tainan
6		M27 BROTHERS
7		M05 Hexacarbonate
8		M35 CoCode.Endeavour
9		M04 Hexahedron

ランキング結果

Sumobot 高校生の部 / High School

Seq	Rank	Country	No.	Name	Point
1	1	 TWN	H13	Profession Stone	51
2	2	 JPN	H06	DJ-Drei Berge	44
3	3	 TWN	H12	Tainan Ying-Hai Haidong No.1	35
4	4	 JPN	H03	ぼくがかんがえた さいきょうのロボット	4
5	5	 JPN	H05	DJ-Side Winder	3

Sumobot (高校生/High School)

1回戦

L1	予選1st	予選Pt.	NO.	H13	Oor	×
		51	Name	Profession Stone		
	予選9th	予選Pt.	NO.		Oor	×
			Name			
	予選6th	予選Pt.	NO.		Oor	×
			Name			
L2	予選2nd	予選Pt.	NO.	H06	Oor	×
		44	Name	DJ-Drei Berge		
	予選8th	予選Pt.	NO.		Oor	×
			Name			
	予選5th	予選Pt.	NO.	H05	Oor	×
		3	Name	DJ-Side Winder		
L3	予選3rd	予選Pt.	NO.	H12	Oor	×
		35	Name	Tainan Ying-Hai Haidong No.1		
	予選7th	予選Pt.	NO.		Oor	×
			Name			
	予選4th	予選Pt.	NO.	H03	Oor	×
		4	Name	ほくがかんがえた さいきょうのロボット		





準決勝

L4	予選1st	NO.	H13	Oor	×
		Name	Profession Stone		○
L5	予選4th	NO.	H03	Oor	×
		Name	ほくがかんがえた さいきょうのロボット		×
L5	予選5th	NO.	H05	Oor	×
		Name	DJ-Side Winder		○
L5	予選2nd	NO.	H06	Oor	×
		Name	DJ-Drei Berge		○
L5	予選3rd	NO.	H12	Oor	×
		Name	Tainan Ying-Hai Haidong No.1		×
L5		NO.		Oor	×
		Name			

決勝









L6	NO.	H13	3rd
	Name	Profession Stone	
L6	NO.	H05	2nd
	Name	DJ-Side Winder	
L6	NO.	H06	1st
	Name	DJ-Drei Berge	
L6	NO.		
	Name		

最終結果

1		H06 DJ-Drei Berge
2		H05 DJ-Side Winder
3		H13 Profession Stone
4		H12 Tainan Ying-Hai Haidong No.1
5		H03 ほくがかんがえた さいきょうのロボット

ランキング結果

Fire Fighting

Seq	Rank	Country	No.	Name	Point
1	1	 JPN	H09	DJ-Fire truck	3482
2	2	 TWN	M28	Tainan Annan Haidong No.1	150
3	3	 TWN	H12	Tainan Ying-Hai Haidong No.1	150
4	4	 JPN	M32	TYHY	0
5	5	 TWN	M27	BROTHERS	0
6	6	 JPN	H08	DJ-Fighting Falcon	0
7	7	 JPN	M33	yoshihirokai!	0
8	8	 CHN	M42	Legend Education-A	0

# Fire Fighting

## 1回戦

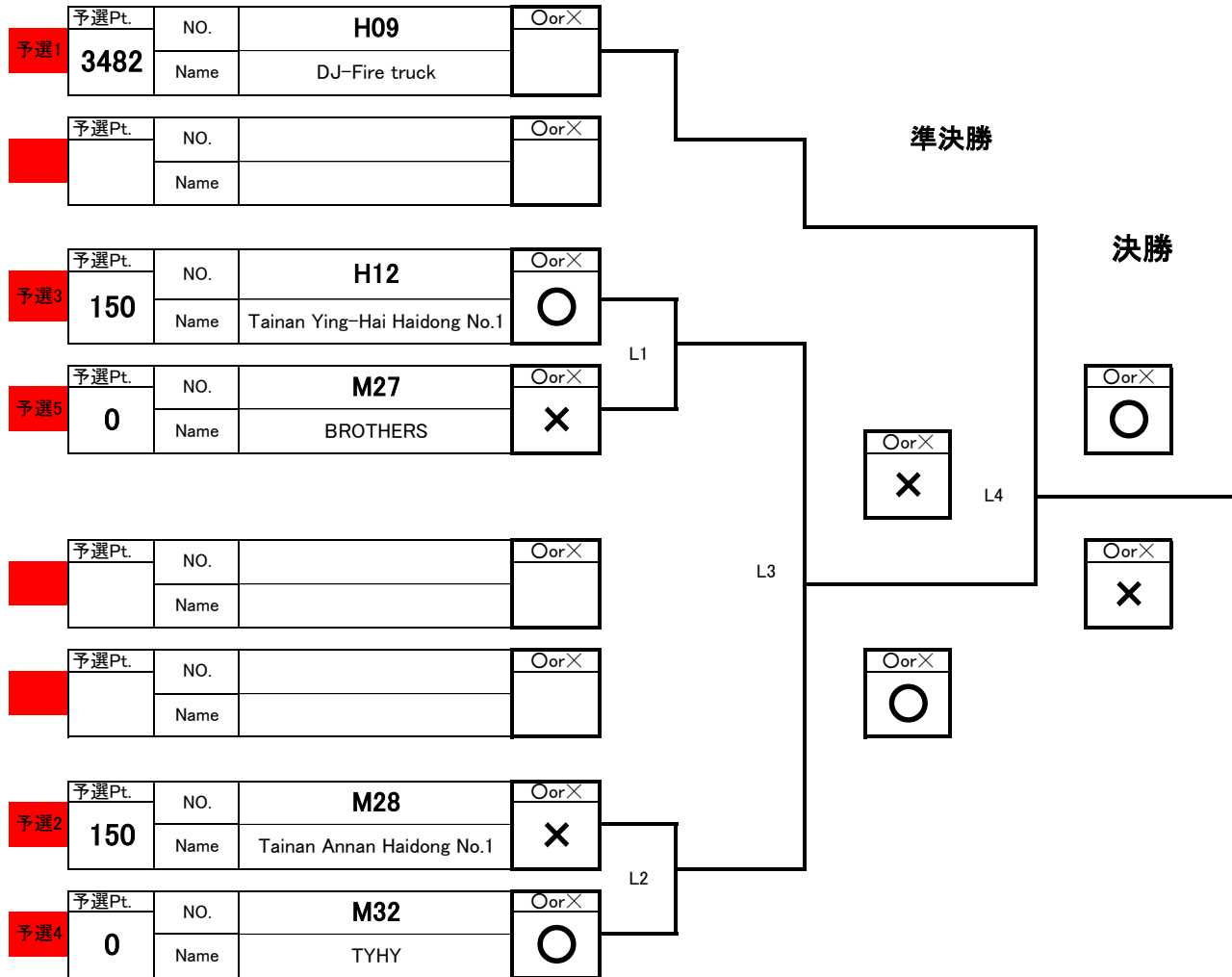



## 最終結果

1		H09 DJ-Fire truck
2		M32 TYHY
3		H12 Tainan Ying-Hai Haidong No.1
4		M28 Tainan Annan Haidong No.1
5		M27 BROTHERS

ランキング結果

Robotovate

Seq	Rank	Country	No.	Name	Point
1	1	 JPN	H02	ウオクシヨソ	72
2	2	 TWN	H12	Tainan Ying-Hai Haidong No.1	71
3	3	 JPN	H04	DJ-Omni	56