



## 入賞チーム

### ●アメージングジャイロ : a-MAZE-ing Gyro

小学生 / Elementary School

Rank	Country	No.	Name
1	 TWN	ES76	Boba Milk Tea
2	 JPN	ES56	39341 (加賀市立作見小学校)
3	 TWN	ES21	Fanatic Pink

中学生 / Middle School

Rank	Country	No.	Name
1	 TWN	MS16	Mystery JH
2	 JPN	MS09	東和中学校卓球部 (加賀市立東和中学校)
3	 TWN	MS12	徳光genius

### ●アメージング : a-MAZE-ing

小学生 / Elementary School



Rank	Country	No.	Name
1	 TWN	ES39	麻豆小六隊
2	 TWN	ES26	Tainan No.1
2	 TWN	ES34	Tainan Sinyi Super Player

中学生 / Middle School

Rank	Country	No.	Name
1	 TWN	MS19	Taiwan Diana
2	 TWN	MS33	麥克機快 Robots Go Fast
3	 TWN	MS22	WWL Dream High

### ●ラインフォロイング : Line Following



小学生 / Elementary School

Rank	Country	No.	Name
1	 TWN	ES72	pink lollipop
2	 TWN	ES75	Bubble tea
3	 TWN	ES17	Makerstation- B

中学生 / Middle School



Rank	Country	No.	Name
1	 CHN	MS06	LightUp-KnightA
2	 TWN	MS23	Tmikog
3	 TWN	MS33	麥克機快 Robots Go Fast

高校生 / High School



Rank	Country	No.	Name
1	 CHN	HS25	LightUp-Friends
2	 CHN	HS26	Genshin
3	 CHN	HS28	Winning Team

●スモロボット : Sumobot

小学生 / Elementary School

Rank	Country	No.	Name
1	 TWN	ES21	Fanatic Pink
2	 TWN	ES23	Guinan Pearl Oolong
3	 TWN	ES27	Tainan Haidong Voltron

中学生 / Middle School

Rank	Country	No.	Name
1	 TWN	MS48	Chicken Karaage
2	 SIN	MS45	SSTeel
3	 TWN	MS18	Annan MVP

高校生 / High School

Rank	Country	No.	Name
1	 TWN	HS17	DREAMER
2	 TWN	HS01	MIT
3	 TWN	HS21	沒有東西

●ファイヤーファイティング : Fire Fighting

中学生 / Middle School

Rank	Country	No.	Name
1	 TWN	MS52	nuggets
2	 TWN	MS17	Tainan Annan Crazy Raiders
3	 TWN	MS51	FR

高校生 / High School



Rank	Country	No.	Name
1	 TWN	HS29	Sea Bull
2	 TWN	HS30	Fire King
3	 TWN	HS34	W²H

●アントレプレナー : Entrepreneurial



Rank	Country	No.	Name
1	 TWN	HS20	沒有東西
2	 TWN	HS06	Fearless
3	 TWN	HS38	Bike World Tour

●アルペンボット : AlpineBot



小学生 / Elementary School

Rank	Country	No.	Name
1	 TWN	ES26	Tainan No.1
2	 TWN	ES27	Tainan Haidong Voltron
3	 TWN	ES25	Tainan Haidong Guaiguai

中学生 / Middle School



Rank	Country	No.	Name
1	 TWN	MS16	Mystery JH
2	 TWN	MS17	Tainan Annan Crazy Raiders
3	 TWN	MS18	Annan MVP

高校生 / High School

Rank	Country	No.	Name
1	 TWN	HS03	Mystery SH
2	 TWN	HS04	Tainan robo
3	 TWN	HS05	Hello Monkey

●オンライン ファストボット : Online FastBot



小学生 / Elementary School

Rank	Country	No.	Name
1	 TWN	ES82	The Pink Attitudes
2	 TWN	ES84	Pink Panther
3	 TWN	ES83	Tickled Pink

中学生 / Middle School

Rank	Country	No.	Name
1	 CHN	MS59	LightUp-KnightA
2	 TWN	MS60	探險隊
3	 TWN	MS61	NK-JE

高校生 / High School

Rank	Country	No.	Name
1	 CHN	HS41	LightUp-Friends
2	 TWN	HS43	Love dragon
3	 TWN	HS42	Love snow

ランキング結果

a-MAZE-ing 小学生の部 / Elementary School

Seq	Rank	Country	No.	Name	Point
1	1	 TWN	ES39	麻豆小六隊	3080
2	1	 TWN	ES26	Tainan No.1	3080
3	1	 TWN	ES34	Tainan Sinyi Super Player	3080
4	1	 TWN	ES30	Jiali Best	3080
5	5	 TWN	ES22	Pink Warriors	3076
6	6	 TWN	ES21	Fanatic Pink	3075
7	7	 TWN	ES29	新泰人	3070
8	7	 TWN	ES27	Tainan Haidong Voltron	3070
9	9	 TWN	ES78	C.E.R	3059
10	10	 JPN	ES20	栄光ロボットアカデミー横浜校v	3051
11	11	 JPN	ES05	いりはし	3046
12	12	 JPN	ES33	YUの達人	3044
13	13	 JPN	ES64	KI2 (ケイアイツー)	3041
14	14	 JPN	ES44	ウィルキッズチーム	3031
15	15	 JPN	ES19	栄光ロボットアカデミー横浜校a	3026
16	16	 JPN	ES08	がんばる河南	3025
17	17	 JPN	ES06	ロボ2023	3021
18	18	 JPN	ES42	ちょこちっぷです!	2990
19	19	 TWN	ES77	Triple Y	2987
20	20	 JPN	ES62	片小B	2842
21	21	 JPN	ES53	南郷ロボレ	2795
22	22	 JPN	ES38	加賀市立錦城小学校D	2687
23	23	 JPN	ES61	片小A	2506
24	24	 JPN	ES45	きんひがジュニア	2318
25	25	 JPN	ES12	ニコニコ河南	2250
26	25	 JPN	ES37	加賀市立錦城小学校C	2250
27	25	 JPN	ES40	バクスナ	2250
28	25	 JPN	ES43	スターロボの伝説2	2250
29	25	 JPN	ES58	金明5年ロボ	2250
30	30	 JPN	ES47	ピーナッツバターブラザーズ	2050
31	30	 JPN	ES59	金明4年ロボ	2050
32	30	 JPN	ES60	KOHOKU	2050
33	33	 JPN	ES52	山代小学校5・6年	2025
34	34	 JPN	ES09	BIBABIBO	1950
35	34	 JPN	ES35	加賀市立錦城小学校A	1950
36	36	 JPN	ES41	非常口	1887
37	37	 JPN	ES07	悠琉月チーム	1859
38	38	 JPN	ES57	金明6年ロボ	1850
39	39	 JPN	ES11	ラストシュート	1815
40	40	 JPN	ES36	加賀市立錦城小学校B	1750
41	41	 TWN	ES28	Haidong Chenggong KDM	1500
42	42	 JPN	ES46	HOY ブラザーズ	1250
43	43	 JPN	ES51	山代小学校4年B	900
44	44	 JPN	ES63	片小C	0

a-MAZE-ing (小学生/Elementary School)

1回戦

準決勝

3位決定戦

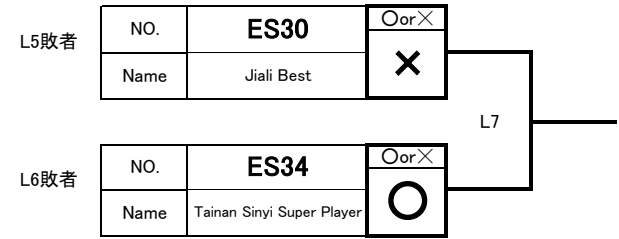
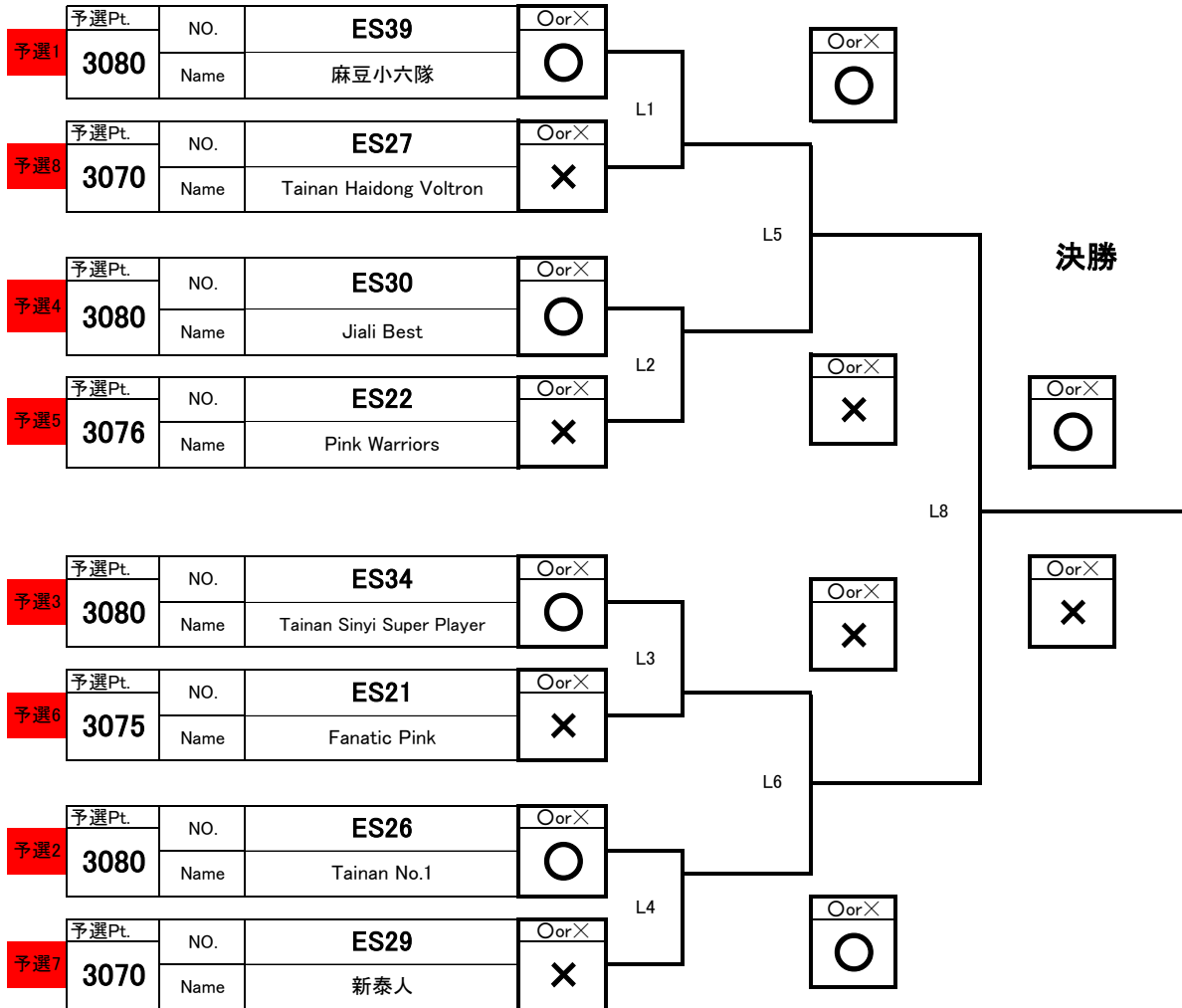









最終結果

1		ES39	麻豆小六隊
2		ES26	Tainan No.1
3		ES34	Tainan Sinyi Super Player
4		ES30	Jiali Best
5		ES22	Pink Wami
6		ES21	Fanatic Pink
7		ES27	Tainan Haidong Voltron
8		ES29	新泰人

ランキング結果

a-MAZE-ing 中学生の部 / Middle School

Seq	Rank	Country	No.	Name	Point
1	1	 TWN	MS33	麥克機快 Robots Go Fast	4570
2	1	 TWN	MS32	JCJH ROBOT	4570
3	3	 TWN	MS19	Taiwan Diana	4560
4	3	 TWN	MS23	Tmikog	4560
5	3	 TWN	MS22	WWL Dream High	4560
6	6	 TWN	MS20	Never give up	4554
7	7	 SIN	MS44	SSTrength	4538
8	8	 JPN	MS14	栄光ロボットアカデミー横浜校	4535
9	9	 JPN	MS02	KTY	4356
10	10	 JPN	MS05	ホモサピエンス	2850
11	11	 JPN	MS43	片山津中学校	2800
12	12	 JPN	MS24	おにぎり	2550
13	13	 JPN	MS01	サバの煮込み汁	2450
14	14	 JPN	MS25	松	2150
15	15	 JPN	MS03	グロック	1550
16	16	 JPN	MS26	Weekend	1500
17	17	 JPN	MS04	miroir	0
18	17	 JPN	MS37	花どろぼう	0
19	17	 JPN	MS38	山中中	0

a-MAZE-ing (中学生/Middle School)

1回戦

準決勝

3位決定戦

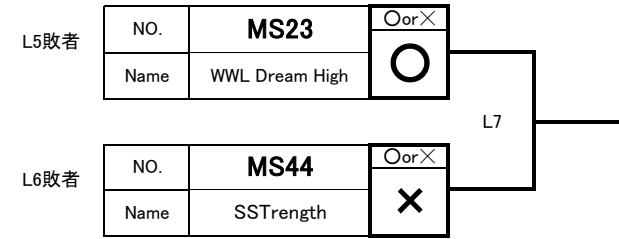
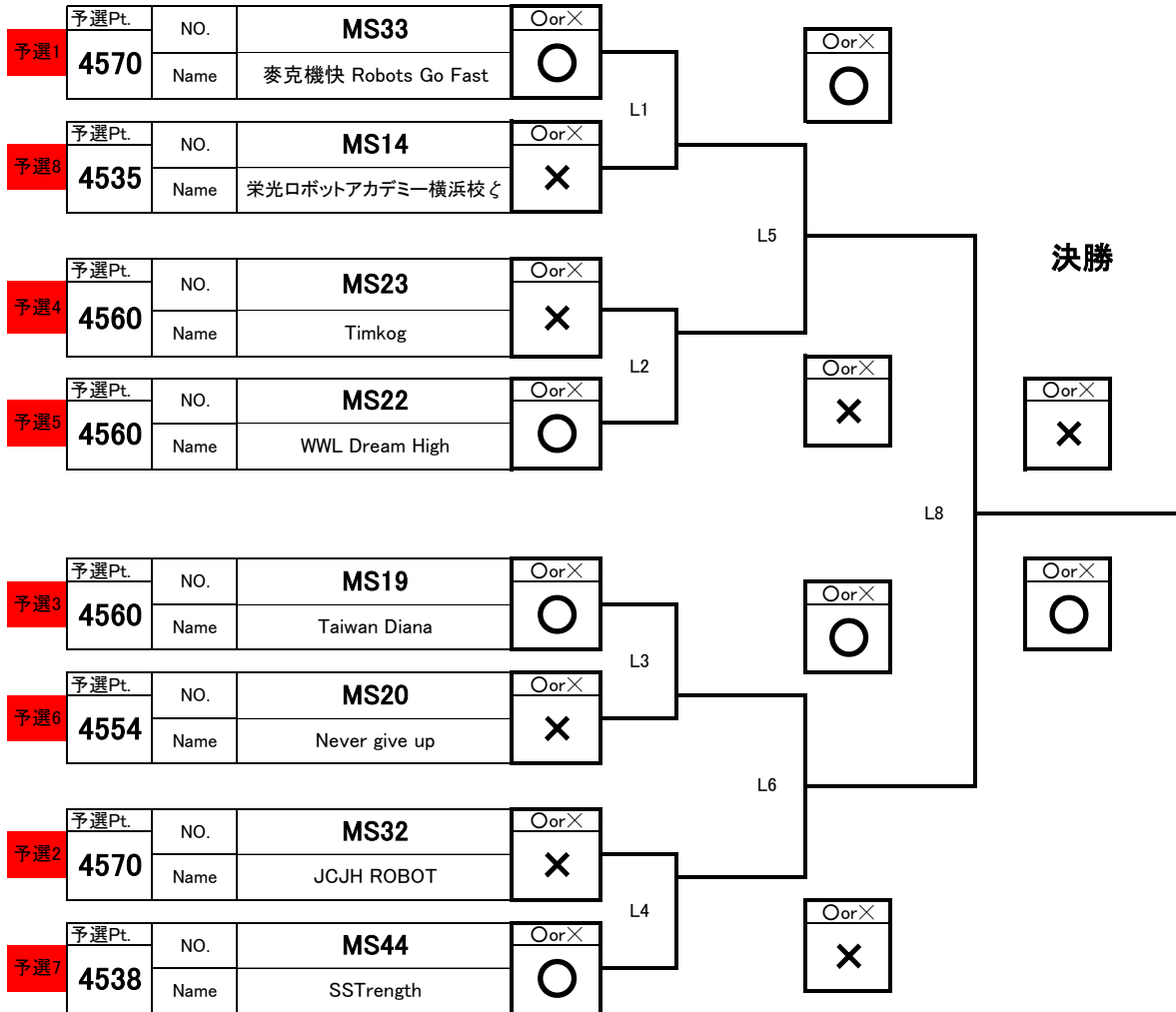

最終結果

1		MS19 Taiwan Diana
2		MS33 麥克機快 Robots Go Fast
3		MS22 WWL Dream High
4		MS44 SSTrength
5		MS32 JCJH ROBOT
6		MS23 Timkog
7		MS20 Never give up
8		MS14 栄光ロボットアカデミー横浜校と

ランキング結果

a-MAZE-ing(Gyro) 小学生の部／Elementary School

Seq	Rank	Country	No.	Name	Point
1	1	 TWN	ES76	Boba Milk Tea	3080
2	1	 TWN	ES30	Jiali Best	3080
3	3	 TWN	ES34	Tainan Sinyi Super Player	3079
4	4	 TWN	ES21	Fanatic Pink	3074
5	5	 JPN	ES55	むらさき	3073
6	6	 TWN	ES22	Pink Warriors	3070
7	6	 JPN	ES56	39341	3070
8	8	 CHN	ES02	LightUp-Spirit	3060
9	9	 TWN	ES29	新泰人	3055
10	10	 CHN	ES01	LightUp-HappyKids	3054
11	11	 JPN	ES54	たご焼4人兄弟	2880

a-MAZE-ing Gyro (小学生 / Elementary School)

1回戦

準決勝

3位決定戦

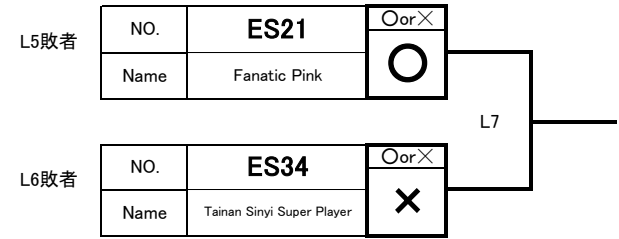
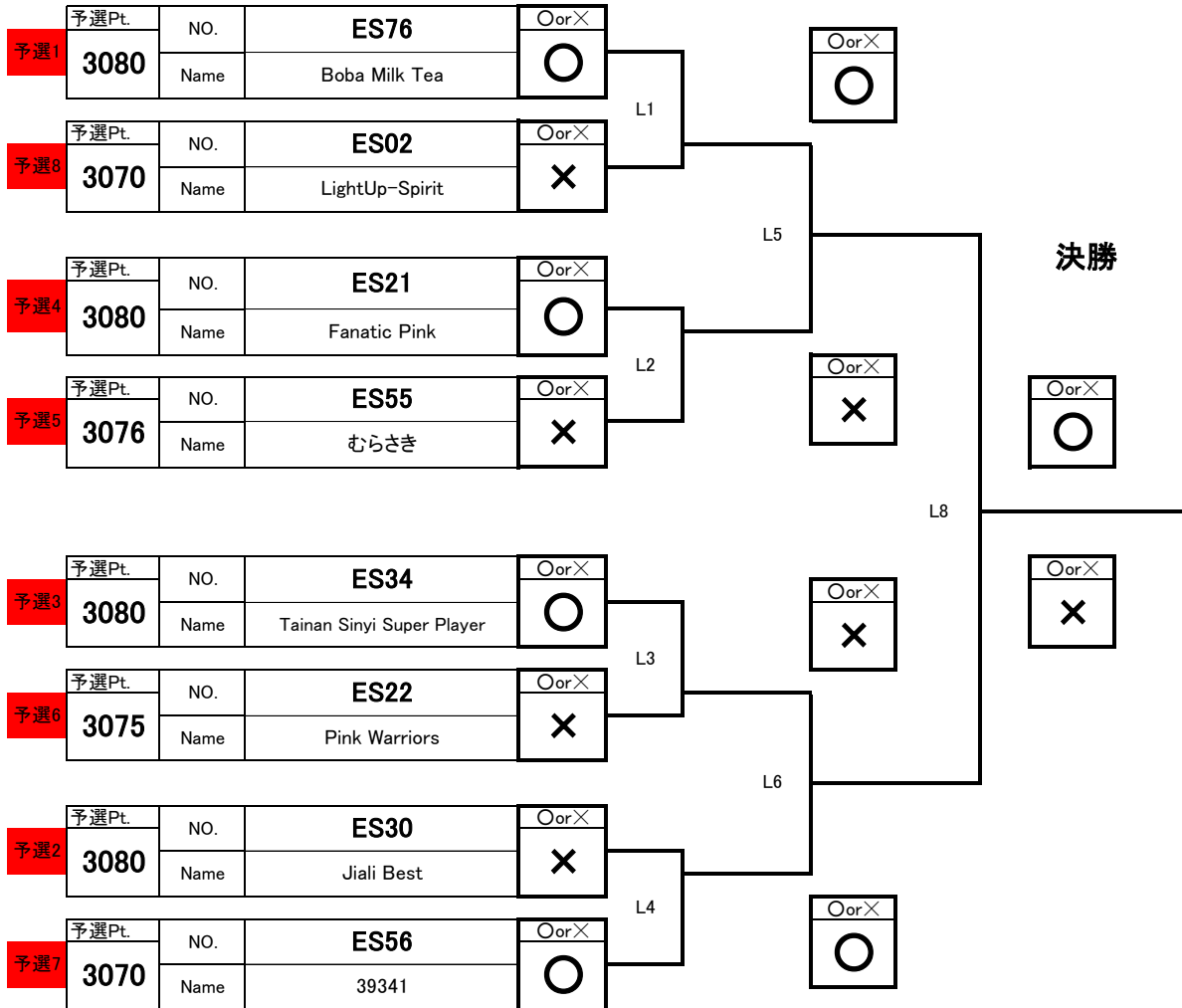

最終結果

1		ES76
		Boba Milk Tea
2		ES56
		39341
3		ES21
		Fanatic Pink
4		ES34
		Tainan Sinyi Super Player
5		ES30
		Jiali Best
6		ES55
		むらさき
7		ES22
		Pink Warriors
8		ES02
		LightUp-Spirit

ランキング結果

a-MAZE-ing(Gyro) 中学生の部/Middle School

Seq	Rank	Country	No.	Name	Point
1	1	 TWN	MS16	Mystery JH	4572
2	2	 TWN	MS22	WWL Dream High	4569
3	3	 TWN	MS12	徳光genius	4560
4	3	 TWN	MS23	Tmikog	4560
5	5	 CHN	MS06	LightUP-KnightA	3915
6	6	 JPN	MS10	東和中学校	3913
7	7	 JPN	MS09	東和中学校卓球部	3412
8	8	 JPN	MS14	栄光ロボットアカデミー横浜校	2400
9	9	 JPN	MS11	東和中学校2	1550

a-MAZE-ing Gyro (中学生/Middle School)

1回戦

準決勝

3位決定戦

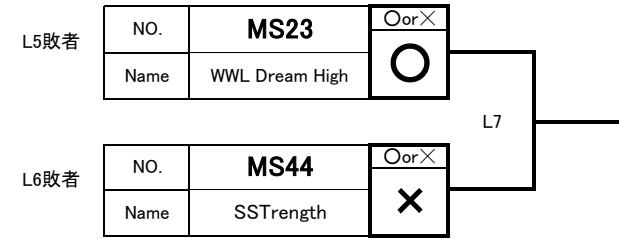
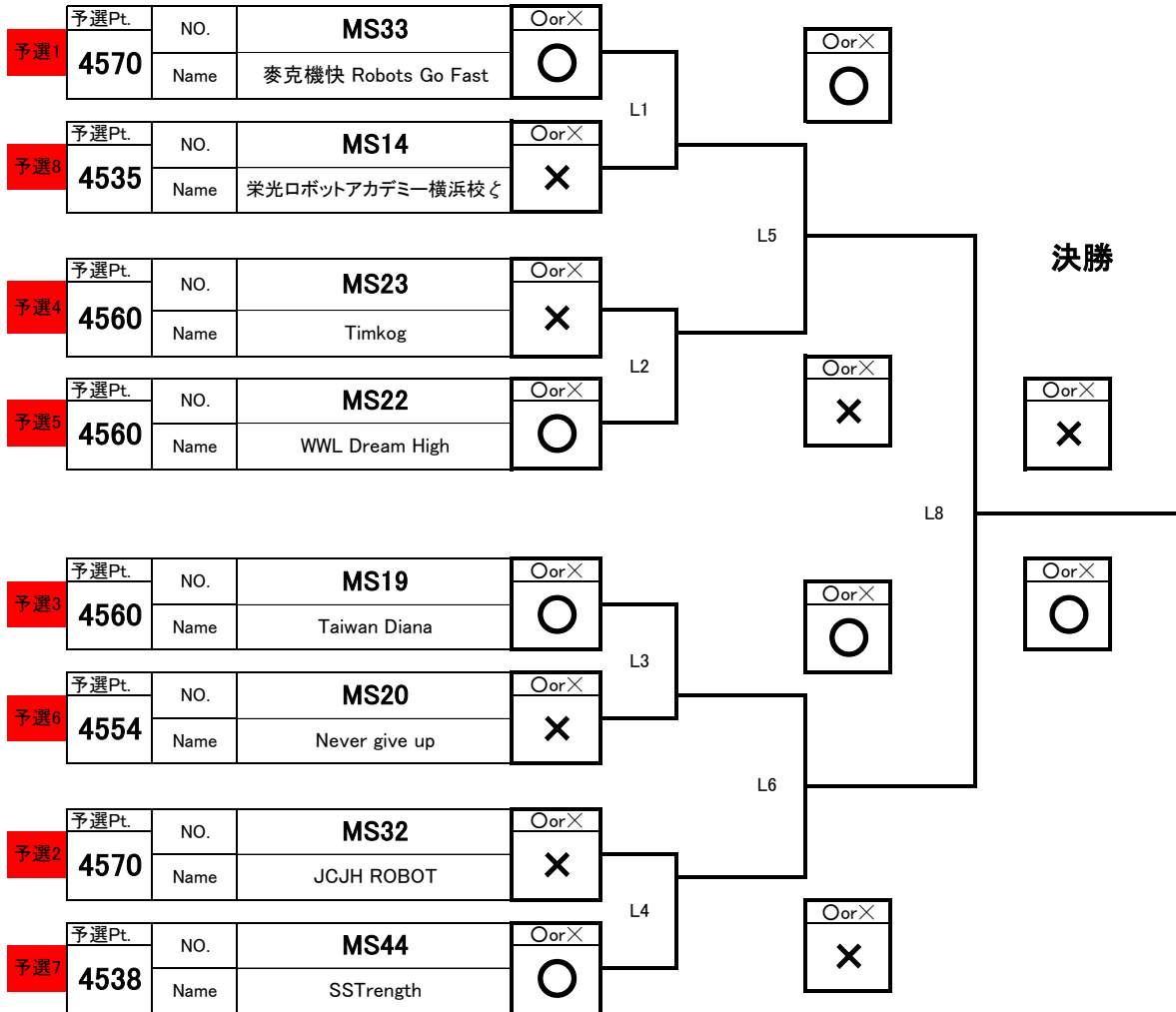

最終結果

1		MS19 Taiwan Diana
2		MS33 麥克機快 Robots Go Fast
3		MS22 WWL Dream High
4		MS44 SSTrength
5		MS32 JCJH ROBOT
6		MS23 Timkog
7		MS20 Never give up
8		MS14 栄光ロボットアカデミー横浜校と

ランキング結果

Line Following 小学生の部 / Elementary School

Seq	Rank	Country	No.	Name	Point
1	1	 TWN	ES18	Makerstation-E	2600
2	1	 TWN	ES17	Makerstation-B	2600
3	1	 TWN	ES72	pink lollipop	2600
4	1	 TWN	ES28	Haidong Chenggong KDM	2600
5	1	 TWN	ES75	Bubble tea	2600
6	1	 TWN	ES71	Gummy bears	2600
7	1	 CHN	ES66	Anshan Youth Robot Association-MARS Sea	2600
8	1	 CHN	ES65	PCMS	2600
9	1	 TWN	ES23	Guinan Pearl Oolong Milk	2600
10	1	 TWN	ES25	Tainan Haidong Guaiguai	2600
11	1	 TWN	ES27	Tainan Haidong Voltron	2600
12	1	 TWN	ES39	麻豆小六隊	2600
13	1	 CHN	ES67	BIBS-Lightning	2600
14	1	 CHN	ES70	Nancheng Fifth Team	2600
15	15	 JPN	ES64	KI2 (ケイアイツー)	2566
16	16	 TWN	ES24	Guinan Champions Team	2561
17	17	 CHN	ES68	Awesome Team	2537
18	18	 JPN	ES20	栄光ロボットアカデミー横浜校v	2480
19	19	 JPN	ES44	ウィルキッズチーム	2280
20	20	 TWN	ES03	Makerstation-A	2229
21	21	 TWN	ES34	Tainan Sinyi Super Player	1939
22	22	 TWN	ES30	Jiali Best	1920
23	23	 CHN	ES02	LightUp-Spirit	1560
24	24	 JPN	ES50	山代小学校4年A	1554
25	25	 JPN	ES15	K.O.T.	700
26	26	 JPN	ES14	おさるチーム	400
27	27	 JPN	ES16	あはたこロボット	200
28	28	 JPN	ES10	河南っ子おあしす	100
29	28	 JPN	ES13	ロボレーバー	100
30	30	 CHN	ES01	LightUp-HappyKids	50
31	31	 TWN	ES04	Taiwan GOGO	0
32	31	 JPN	ES09	BIBABIBO	0
33	31	 JPN	ES19	栄光ロボットアカデミー横浜校a	0

# Line Following (小学生/Elementary School)

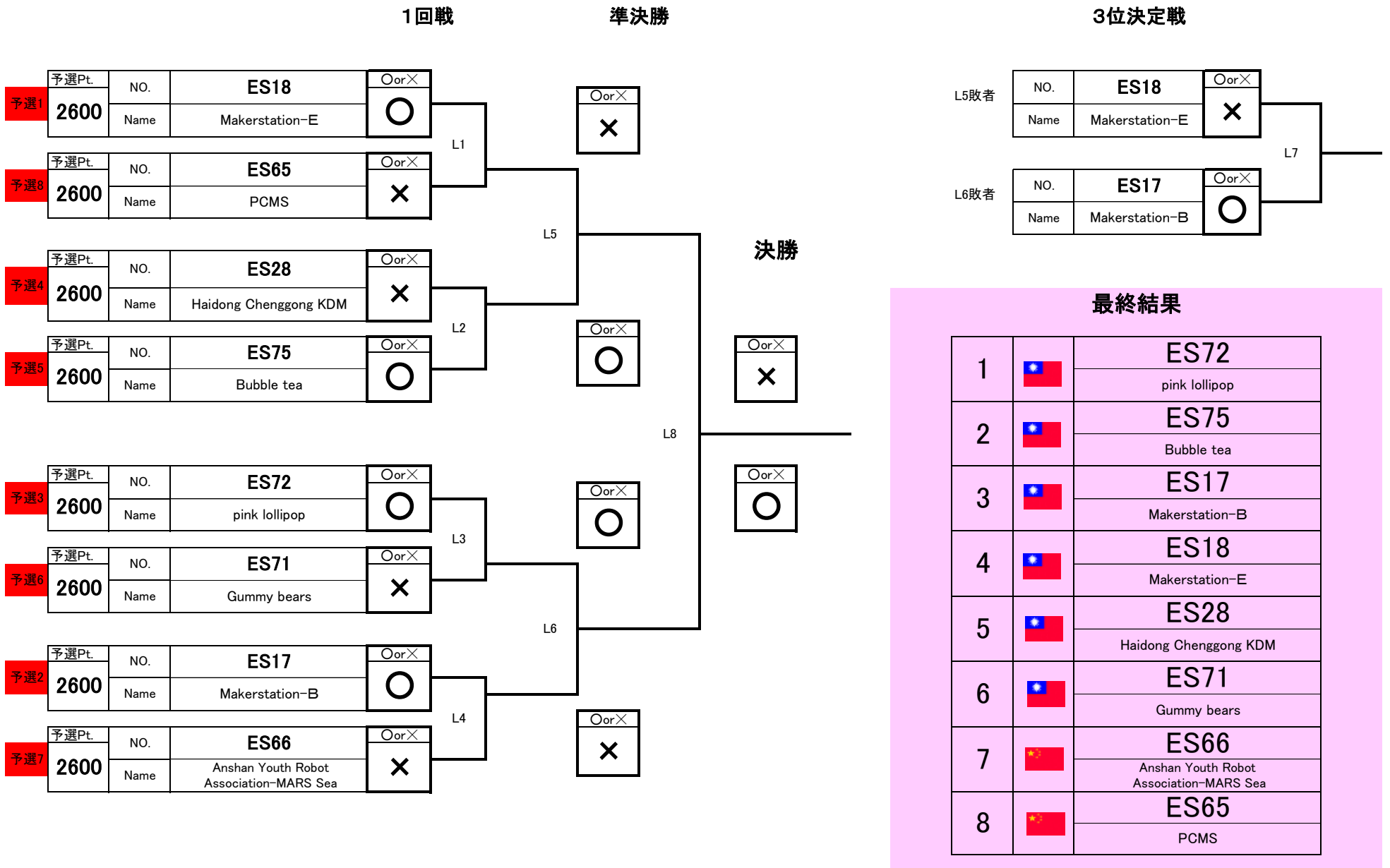

ランキング結果

Line Following 中学生の部/Middle School

Seq	Rank	Country	No.	Name	Point
1	1	 TWN	MS23	Tmikog	3000
2	1	 TWN	MS50	Y.E.W	3000
3	1	 TWN	MS18	Annan MVP	3000
4	1	 JPN	MS31	NAREC3	3000
5	1	 SIN	MS46	SSTalwart	3000
6	1	 CHN	MS06	LightUp-KnightA	3000
7	1	 TWN	MS33	麥克機快 Robots Go Fast	3000
8	8	 TWN	MS54	BIN-HAN-TUNG	2998
9	9	 TWN	MS15	Tainan Jiansing 一番	2997
10	10	 JPN	MS07	朝桜Tempura	2799
11	11	 JPN	MS14	栄光ロボットアカデミー横浜校	2766
12	12	 TWN	MS32	JCJH ROBOT	2651
13	13	 TWN	MS53	Mascot	2400
14	14	 CHN	MS40	BIBS-Racer	2200
15	15	 JPN	MS28	朝桜Bread	2147
16	16	 TWN	MS12	徳光genius	2069
17	17	 JPN	MS30	NAREC2	1966
18	18	 TWN	MS21	ボンボン爆弾	1800
19	19	 TWN	MS47	Funrobot TWO	1775
20	20	 TWN	MS13	Makerstation-D	899
21	21	 TWN	MS57	LH	800
22	22	 SIN	MS45	SSTeel	625
23	23	 JPN	MS09	東和中学校卓球部	325
24	24	 CHN	MS42	BIBS-TDS	300
25	25	 TWN	MS58	TW13	250
26	26	 CHN	MS41	BIBS-Rover	25
27	27	 JPN	MS08	FAY	0
28	27	 TWN	MS16	Mystery JH	0
29	27	 TWN	MS22	WWL Dream High	0
30	27	 JPN	MS27	たけのこ	0
31	27	 JPN	MS29	NAREC1	0
32	27	 JPN	MS34	Otemon leap	0

# Line Following (中学生/Middle School)

## 1回戦

## 準決勝

## 3位決定戦

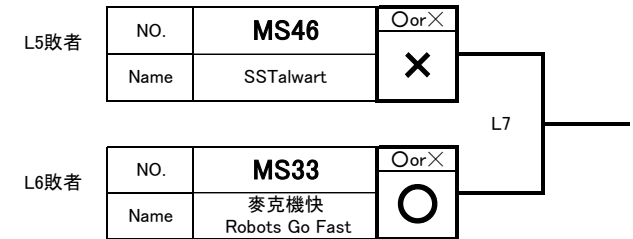
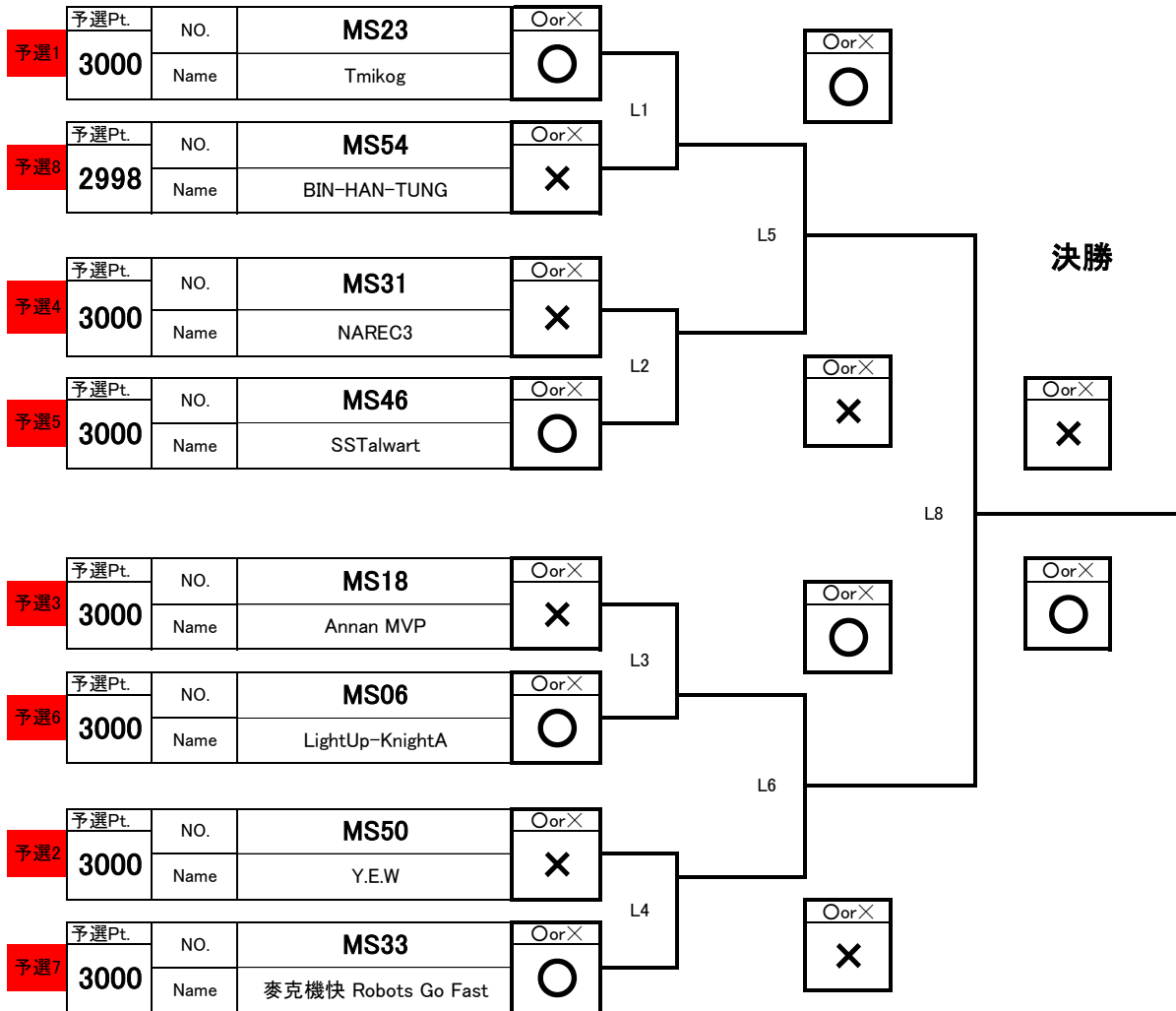

## 最終結果

1		MS06 LightUp-KnightA
2		MS23 Tmikog
3		MS33 麥克機快 Robots Go Fast
4		MS46 SSTalwart
5		MS50 Y.E.W
6		MS18 Annan MVP
7		MS31 NAREC3
8		MS54 BIN-HAN-TUNG

ランキング結果

Line Following 高校生の部 / High School





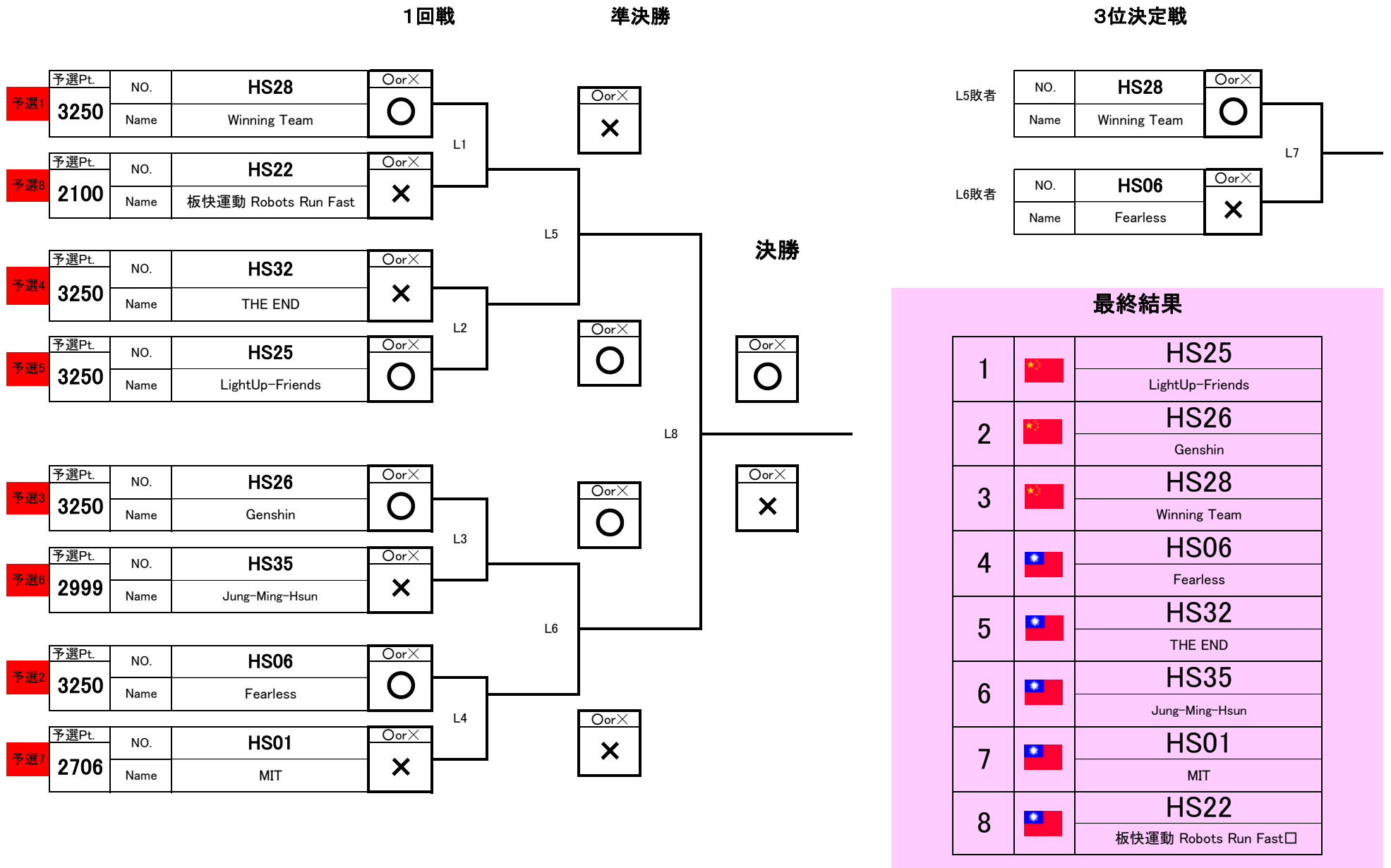











Seq	Rank	Country	No.	Name	Point
1	1	 CHN	HS28	Winning Team	3250
2	1	 TWN	HS06	Fearless	3250
3	1	 CHN	HS26	Genshin	3250
4	1	 TWN	HS32	THE END	3250
5	1	 CHN	HS25	LightUp-Friends	3250
6	6	 TWN	HS35	Jung-Ming-Hsun	2999
7	7	 TWN	HS01	MIT	2706
8	8	 TWN	HS22	板快運動 Robots Run Fast	2100
9	9	 TWN	HS02	Makerstation- C	1975
10	10	 TWN	HS03	Mystery SH	1950
11	11	 JPN	HS13	DJ-TN	575
12	12	 CHN	HS24	MARS Peak	250
13	13	 JPN	HS11	DJ-TS	50
14	14	 JPN	HS12	DJ-TY	0
15	14	 TWN	HS21	沒有東西	0
16	14	 JPN	HS23	NARECō	0
17	14	 CHN	HS27	HRC-Titan	0
18	14	 TWN	HS31	Funrobot ONE	0

# Line Following (高校生/High School)



ランキング結果

Sumobot 小学生の部／Elementary School

Seq	Rank	Country	No.	Name	Point
1	1	 JPN	ES19	栄光ロボットアカデミー横浜校α	30
2	1	 JPN	ES20	栄光ロボットアカデミー横浜校ν	30
3	1	 TWN	ES21	Fanatic Pink	30
4	1	 TWN	ES22	Pink Warriors	30
5	1	 TWN	ES23	Guinan Pearl Oolong Milk	30
6	1	 TWN	ES24	Guinan Champions Team	30
7	1	 TWN	ES25	Tainan Haidong Guaiguai	30
8	1	 TWN	ES26	Tainan No.1	30
9	1	 TWN	ES27	Tainan Haidong Voltron	30
10	1	 TWN	ES28	Haidong Chenggong KDM	30
11	1	 CHN	ES69	Hero Team 1	30
12	1	 TWN	ES73	jumping popcorn	30
13	1	 TWN	ES74	Crazy Coke	30
14	14	 CHN	ES65	PCMS	17
15	15	 JPN	ES48	Big Muscat	16
16	16	 JPN	ES64	KI2 (ケイアイツー)	8
17	17	 TWN	ES04	Taiwan GOGO	0
18	17	 JPN	ES31	マスター・ゴッド	0
19	17	 JPN	ES32	マロン	0
20	17	 TWN	ES34	Tainan Sinyi Super Player	0
21	17	 JPN	ES38	加賀市立錦城小学校D	0

Sumobot (小学生/Elementary School)

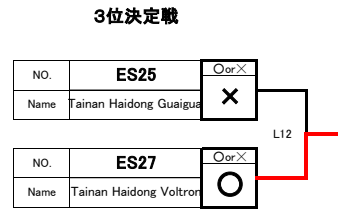
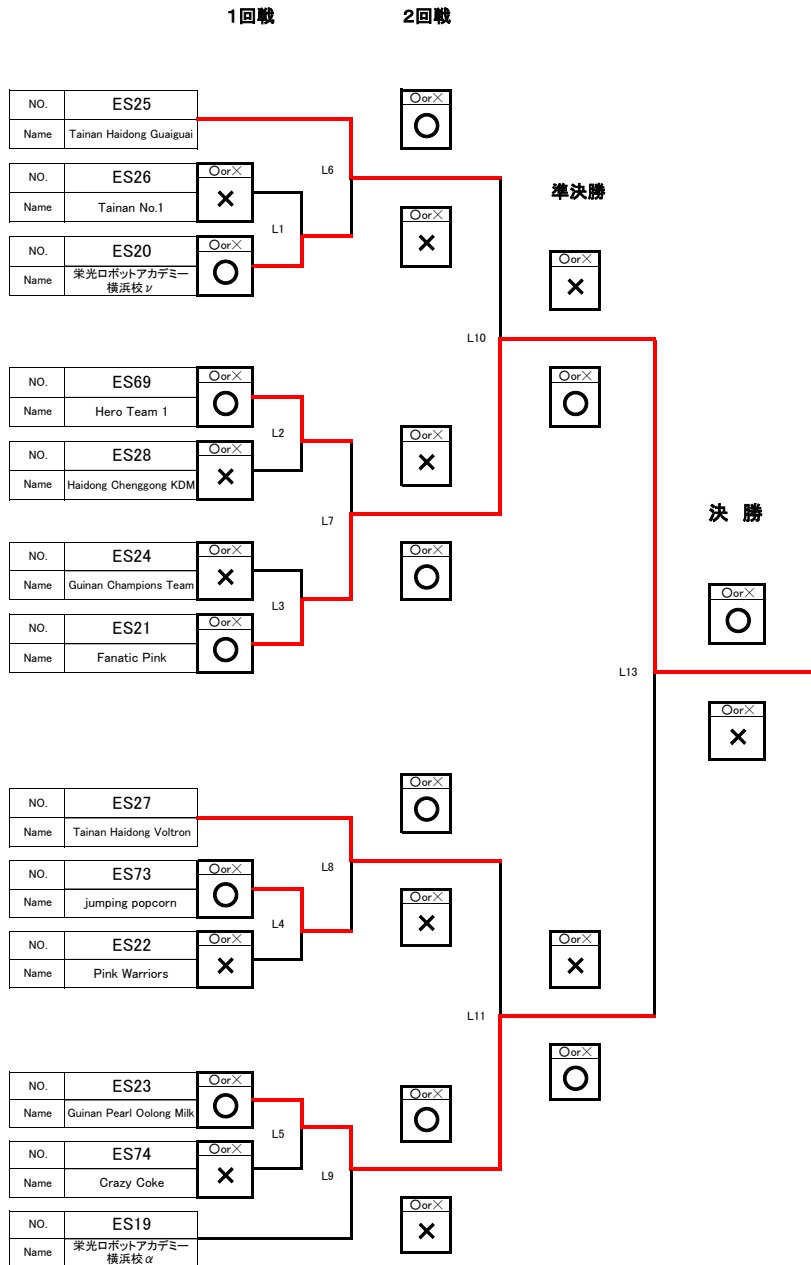









**最終結果**

1		ES21 Fanatic Pink
2		ES23 Guinan Pearl Oolong Milk
3		ES27 Tainan Haidong Voltron
4		ES19 栄光ロボットアカデミー横浜校 α
4		ES20 栄光ロボットアカデミー横浜校 ヴ
4		ES22 Pink Warriors
4		ES24 Guinan Champions Team
4		ES25 Tainan Haidong Guaiguai
4		ES26 Tainan No.1
4		ES28 Haidong Chenggong KDM
4		ES69 Hero Team 1
4		ES73 jumping popcorn
4		ES74 Crazy Coke

ランキング結果

Sumobot 中学生の部 / Middle School

Seq	Rank	Country	No.	Name	Point
1	1	 TWN	MS12	徳光genius	30
2	1	 SIN	MS45	SSTeel	30
3	1	 TWN	MS19	Taiwan Diana	30
4	1	 TWN	MS48	Chicken Karaage	30
5	1	 TWN	MS17	Tainan Annan Crazy Raiders	30
6	1	 TWN	MS18	Annan MVP	30
7	1	 SIN	MS46	SSTalwart	30
8	1	 TWN	MS20	Never give up	30
9	9	 SIN	MS44	SSTrength	18
10	10	 JPN	MS14	栄光ロボットアカデミー横浜校	0
11	10	 TWN	MS33	麥克機快 Robots Go Fast	0
12	10	 JPN	MS35	詳徳ましゅまる	0
13	10	 CHN	MS36	詳徳あゆ	0

# SumoBot (中学生/Middle School)

## 1回戦

## 準決勝

## 3位決定戦

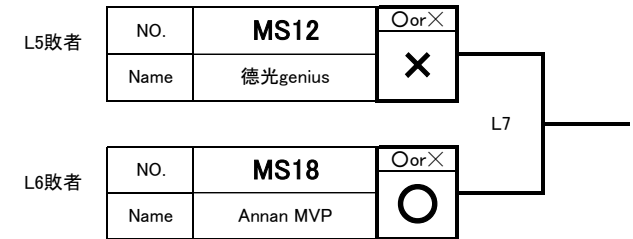
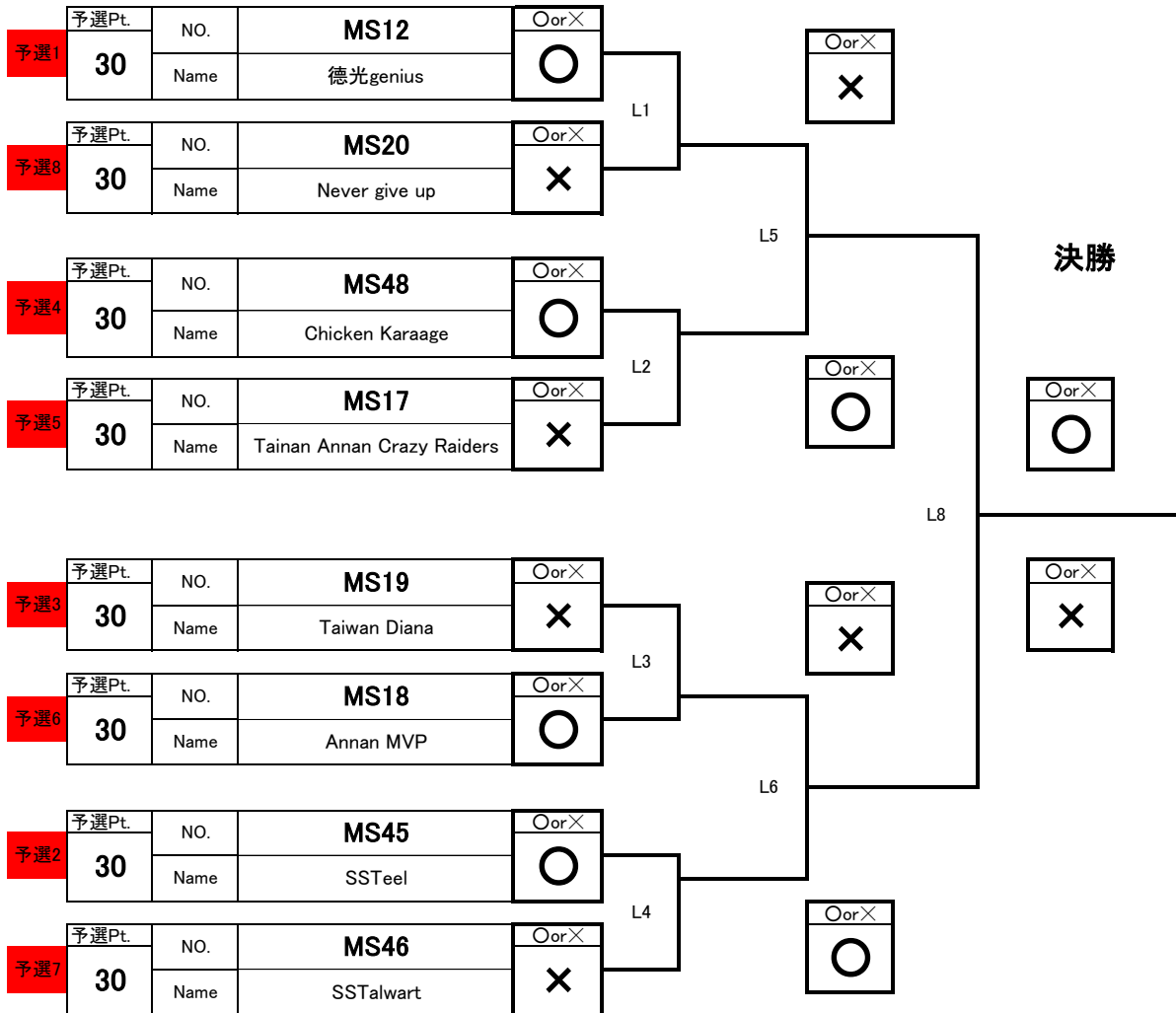

## 最終結果

1		<b>MS48</b> Chicken Karaage
2		<b>MS45</b> SSTeel
3		<b>MS18</b> Annan MVP
4		<b>MS12</b> 德光genius
5		<b>MS19</b> Taiwan Diana
6		<b>MS17</b> Tainan Annan Crazy Raiders
7		<b>MS46</b> SSTalwart
8		<b>MS20</b> Never give up

ランキング結果

Sumobot 高校生の部 / High School

Seq	Rank	Country	No.	Name	Point
1	1	 JPN	HS20	グループビー松本	30
2	1	 JPN	HS14	DJ-伊藤園	30
3	1	 TWN	HS17	DREAMER	30
4	1	 TWN	HS06	Fearless	30
5	1	 JPN	HS15	DJ-エリザベス	30
6	1	 TWN	HS05	Hello Monkey	30
7	1	 TWN	HS21	沒有東西	30
8	1	 TWN	HS01	MIT	30
9	9	 TWN	HS04	Tainan robo	24
10	10	 TWN	HS22	板快運動 Robots Run Fast	0
11	10	 CHN	HS28	Winning Team	0

# SumoBot (高校生/High School)

## 1回戦

## 準決勝

## 3位決定戦

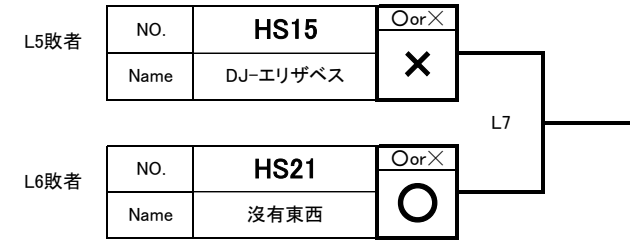
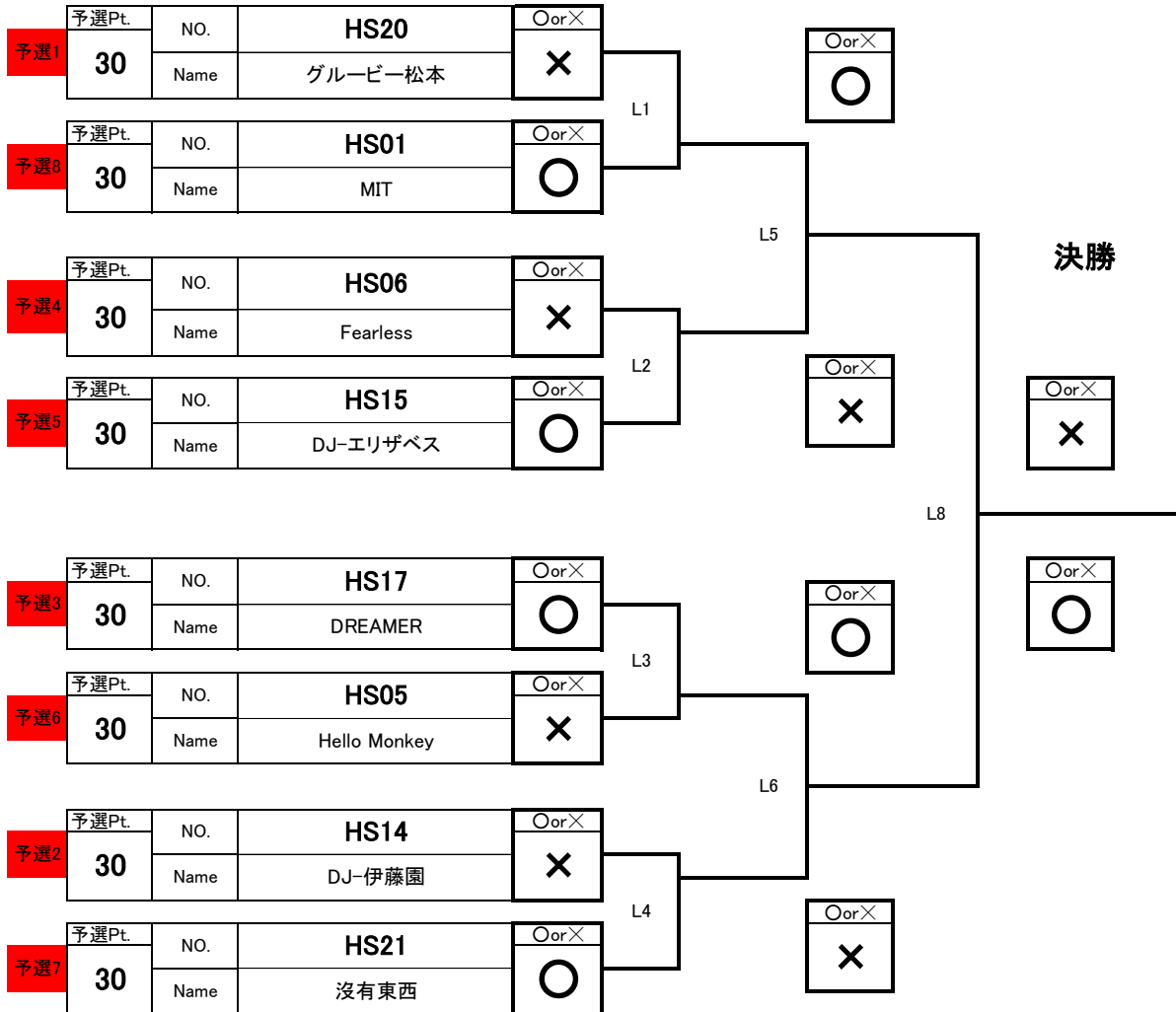





## 最終結果

1		HS17
		DREAMER
2		HS01
		MIT
3		HS21
		沒有東西
4		HS15
		DJ-エリザベス
5		HS20
		グルービー松本
6		HS14
		DJ-伊藤園
7		HS06
		Fearless
8		HS05
		Hello Monkey

ランキング結果

Fire Fighting 中学生の部 / Middle School

Seq	Rank	Country	No.	Name	Point
1	1	 TWN	MS52	nuggets	3514
2	2	 TWN	MS18	Annan MVP	900
3	3	 TWN	MS17	Tainan Annan Crazy Raiders	700
4	4	 TWN	MS51	FR	600

# Firefighting (中學生/Middle School)

## 1回戦

## 準決勝

## 3位決定戦

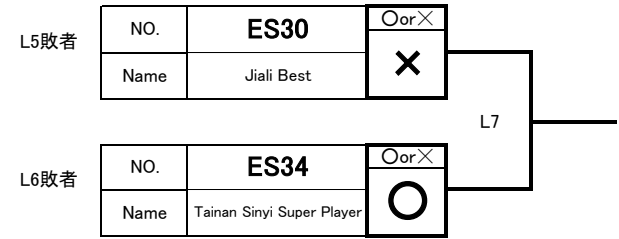
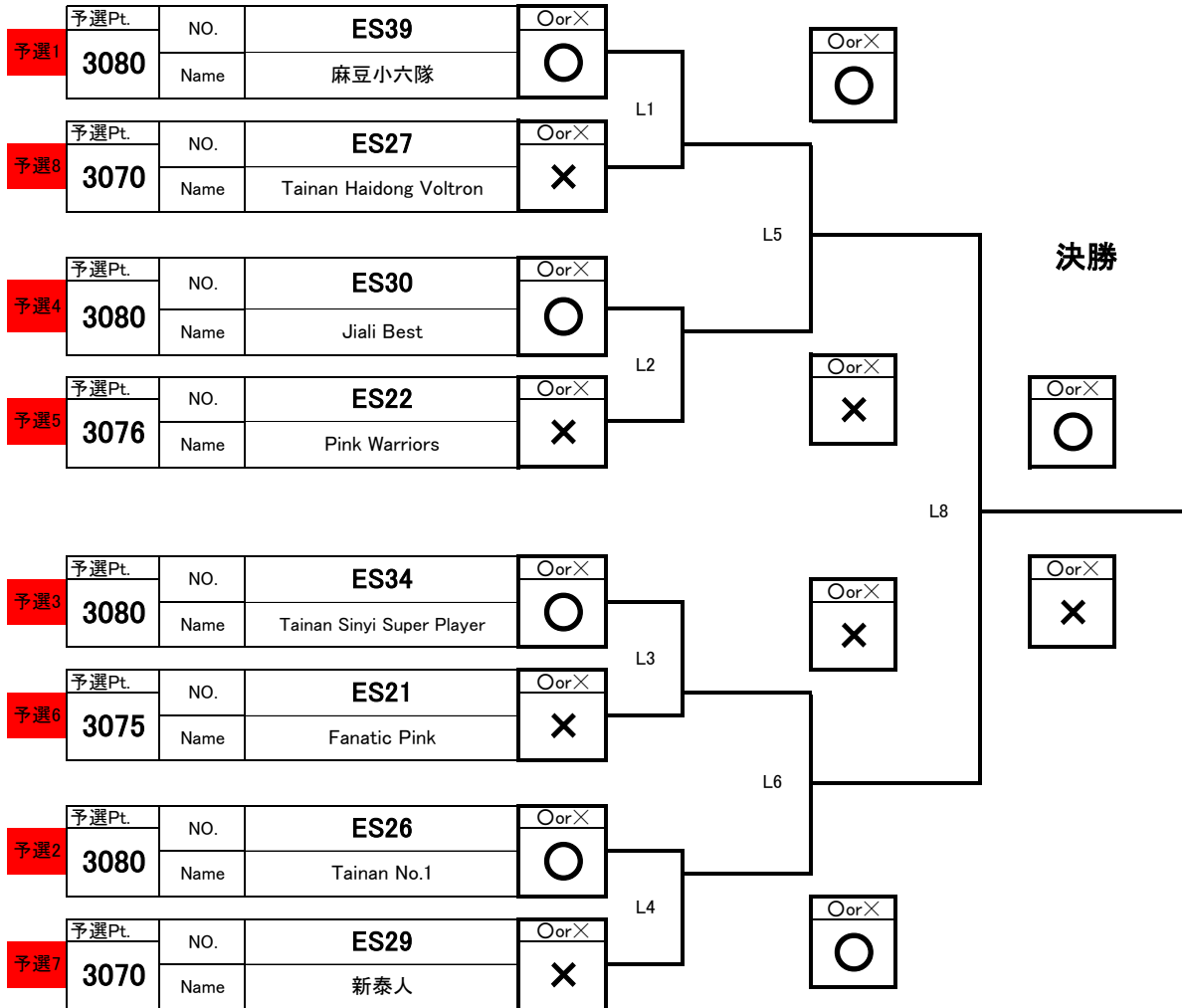









## 最終結果

1		ES39 麻豆小六隊
2		ES26 Tainan No.1
3		ES34 Tainan Sinyi Super Player
4		ES30 Jiali Best
5		ES22 Pink Wami
6		ES21 Fanatic Pink
7		ES27 Tainan Haidong Voltron
8		ES29 新泰人

ランキング結果

Fire Fighting 高校生の部 / High School

Seq	Rank	Country	No.	Name	Point
1	1	 TWN	HS30	Fire King	3242
2	2	 TWN	HS39	Aii is Well	3233
3	3	 TWN	HS01	MIT	2600
4	4	 TWN	HS34	W <sub>2</sub> H	2200
5	5	 TWN	HS04	Tainan robo	1450
6	6	 TWN	HS29	Sea Bull	1300
7	7	 JPN	HS10	DJ-FF	1200
8	8	 JPN	HS09	DJ-2023	1100
9	9	 TWN	HS05	Hello Monkey	700

Firefighting (高校生/High School)

1回戦

準決勝

3位決定戦

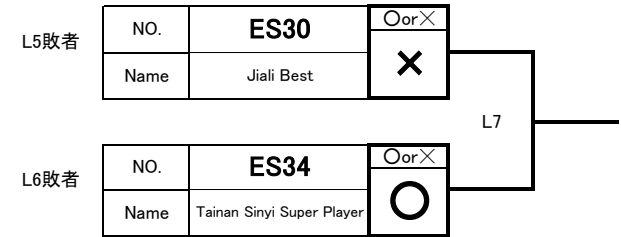
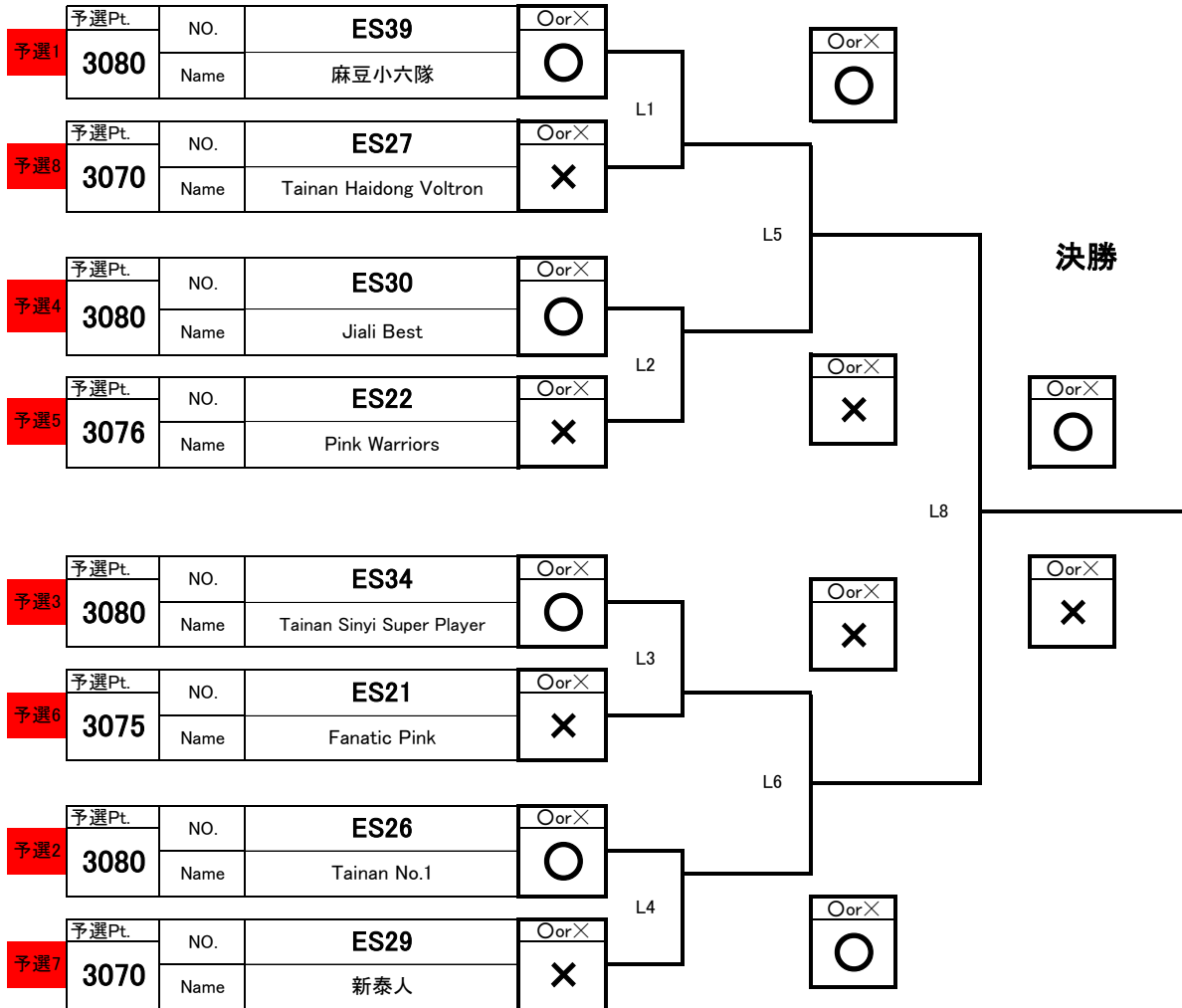







最終結果

1		ES39	麻豆小六隊
2		ES26	Tainan No.1
3		ES34	Tainan Sinyi Super Player
4		ES30	Jiali Best
5		ES22	Pink Wami
6		ES21	Fanatic Pink
7		ES27	Tainan Haidong Voltron
8		ES29	新泰人



ランキング結果

AlpineBot 小学生の部／Elementary School

Seq	Rank	Country	No.	Name	Point
1	1	 TWN	ES26	Tainan No.1	3742
2	2	 TWN	ES27	Tainan Haidong Voltron	3091
3	3	 TWN	ES25	Tainan Haidong Guaiguai	2676
4	4	 TWN	ES21	Fanatic Pink	1508
5	5	 TWN	ES28	Haidong Chenggong KDM	1300
6	6	 TWN	ES22	Pink Warriors	1275
7	7	 JPN	ES49	わんぱく団	300
8	8	 TWN	ES04	Taiwan GOGO	0

ランキング結果

AlpineBot 中学生の部／Middle School

Seq	Rank	Country	No.	Name	Point
1	1	 TWN	MS16	Mystery JH	4011
2	2	 TWN	MS17	Tainan Annan Crazy Raiders	3915
3	3	 TWN	MS18	Annan MVP	3810
4	4	 TWN	MS19	Taiwan Diana	3009
5	5	 TWN	MS20	Never give up	680

ランキング結果

AlpineBot 高校生の部 / High School

Seq	Rank	Country	No.	Name	Point
1	1	 TWN	HS03	Mystery SH	3971
2	2	 TWN	HS04	Tainan robo	3625
3	3	 TWN	HS05	Hello Monkey	3236
4	4	 JPN	HS08	DJ-KH	3137
5	5	 TWN	HS06	Fearless	1323
6	6	 TWN	HS01	MIT	1240
7	7	 JPN	HS07	DJ-ナリカワ	1084
8	8	 JPN	HS18	いまがわやき	380
9	9	 JPN	HS19	たい焼き	160
10	10	 CHN	HS24	MARS Peak	0
11	10	 TWN	HS29	Sea Bull	0





ランキング結果

Entrepreneurial

Seq	Rank	Country	No.	Name	Point
1	1	 TWN	HS21	沒有東西	72
2	2	 TWN	HS06	Fearless	71
3	3	 TWN	HS38	Bike World Tour	45
4	4	 CHN	MS39	Dream Song	40
5	5	 TWN	HS40	G.W.S	32
6	6	 TWN	HS03	Mystery SH	29
7	7	 JPN	HS16	DJ-Handstand	28
8	8	 TWN	MS49	QQ1	13
9	9	 TWN	HS36	CABBAGE	12
10	10	 TWN	HS33	QQ2	6
11	11	 TWN	MS56	WinnerDuo	5
12	11	 TWN	HS37	Health Helper	5
13	13	 TWN	MS55	P.Y.C	3
14	14	 CHN	HS25	Light up-Friends	0

ランキング結果

FastBot Online 小学生の部 / Elementary School

Seq	Rank	Country	No.	Name	Point
1	1	 TWN	ES82	Tainan Wujia Glory	494
2	2	 TWN	ES84	Tainan Haidong Star	492
3	3	 TWN	ES83	Tainan Wujia Luxembourg Knights	444
4	4	 TWN	ES80	SLPS Super Robot	100
5	4	 TWN	ES81	Tainan Wujia Stars	100
6	6	 TWN	ES79	Wenhua Miracle	0



ランキング結果

FastBot Online 中学生の部 / Middle School

Seq	Rank	Country	No.	Name	Point
1	1	 CHN	MS59	LightUp-KnightA	504
2	2	 TWN	MS60	探險隊	501
3	3	 TWN	MS61	NK-JE	464

ランキング結果

FastBot Online 高校生の部 / High School

Seq	Rank	Country	No.	Name	Point
1	1	 CHN	HS41	LightUp-Friends	499
2	2	 TWN	HS43	Love dragon	420
3	3	 TWN	HS42	Love snow	300